

—
KRONOTERM 1976
HEAT PUMPS

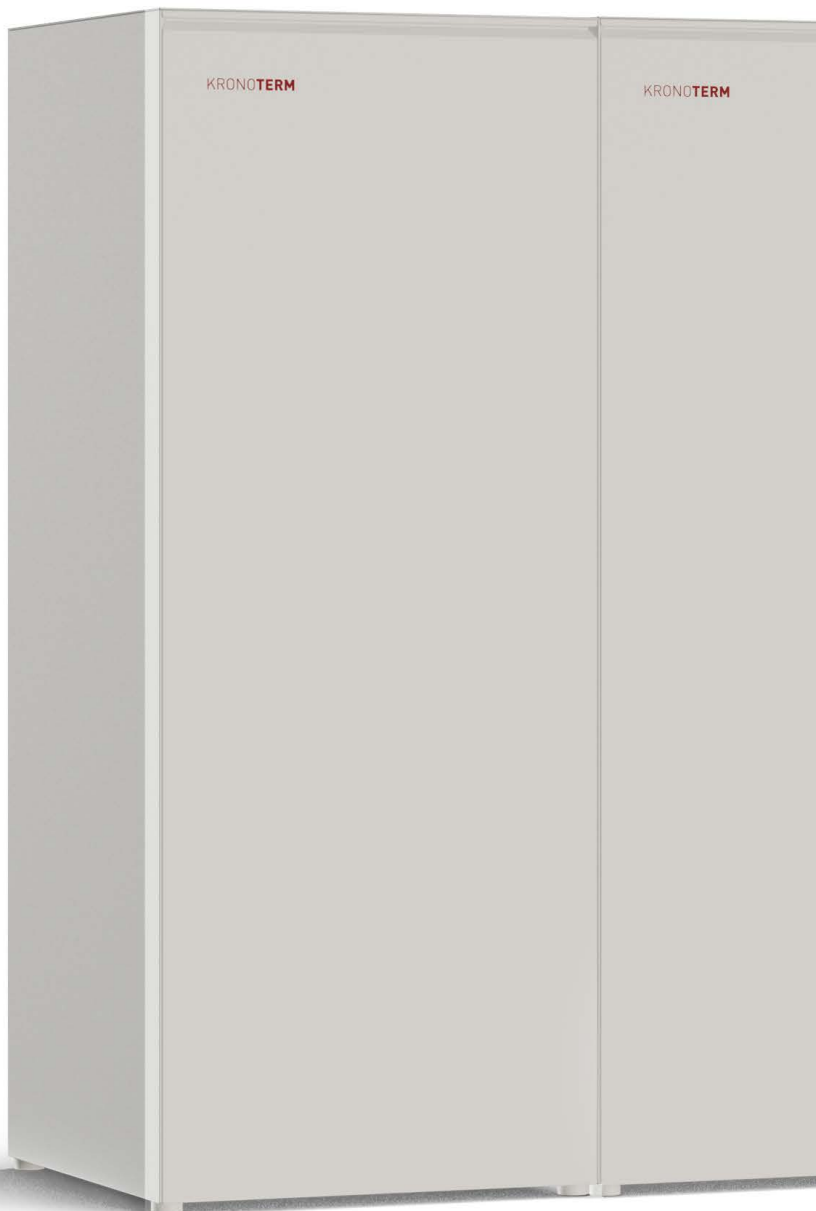

—
DATA SHEET

—
ETERA
heat pump

Data sheet - ETERA - EN / 98-23-19-220003-05

This work is protected by copyright. Any use of this document outside of the Copyright and Related Rights Act and without the express consent of KRONOTERM d.o.o. is illegal and punishable by fine.

Despite taking extensive care to ensure the accuracy of all figures and descriptions, KRONOTERM d.o.o. reserves the right to make corrections, changes to technical details, and changes to figures with no prior notice. Information herein is given based on the latest available product information at the time of drafting and printing this product sheet. All data are preliminary. We also reserve the right to suspend the sales of an individual product or even the entire sales program.

All document updates are available in digital format. Please contact your chosen system administrator for access.

Figures are symbolic and are only intended as a reference. Despite our efforts we cannot ensure that the products' true colors, proportions, or other graphical elements will be faithfully represented in print and on electronic screens. Products may differ from their visual representations.

Printed in Slovenia.

The original documentation is written in Slovenian. All other languages are translations.

Write to info@kronoterm.com for any additional questions.

INDEX

DESCRIPTION	4
Technology.....	4
NOMENCLATURE	5
CONFIGURATION	5
ETERA HEAT PUMP	6
Primary components.....	7
HEAT PUMP ETERA-C	8
Description and dimensions.....	8
HEAT PUMP ETERA-C	9
Main components.....	9
HYDRO B DHW MODULE	10
Primary components.....	11
ADDITIONAL MODULES OF THE ETERA SYSTEM	13
Additional modules for the heat pump	13
Additional modules for HYDRO B(A).....	14
ETERA system connection sets.....	14
HYDRO BA.....	15
1:1 SCALE TEMPLATE FOR THE CONNECTION PREPARATION	16
Suitable template selection	16
ADDITIONAL EQUIPMENT ETERA.....	17
Mandatory accessories	17
Connection set ETERA-C	17
Equipment for the heating system.....	17
Additional modules for ETERA-C.....	17
ELECTRO MODULES.....	19
MODULE HYDRO PWM-R	19
KIT FOR UPGRADING A 2-WIRE CABLE	19
GROUNDWATER PUMPING KIT	19
BASIC KSM REGULATOR	20
Functional characteristics	20
KSM+ 2 EXPANSION MODULE	20
Functional characteristics	20
CONTROL EQUIPMENT.....	21
KT-2A CONTROLLER.....	21
Functional characteristics	21
THERMOSTAT KT-1.....	21
Functional characteristics	21
CLOUD.KRONOTERM.....	22
Functional characteristics	22
TECHNICAL DATA.....	23
SOUND	26
PERFORMANCE AND EFFICIENCY	28
OPERATING RANGE	30
CAPACITY CURVES.....	31
BASIC INSTALLATION DIAGRAM	33
ETERA system with horizontal geothermal collector.....	33
ETERA system with vertical geothermal collector	34
ETERA system with groundwater heat source	35
ETERA system with groundwater heat source and MODUL_PIL-PASIVA ETERA for passive cooling.....	36
ETERA cascade system with groundwater heat source	37

WELCOME TO THE KRONOTERM FAMILY!

We have prepared a data sheet for you, which describes the technical features of the ETERA heat pump system.

DESCRIPTION

The modular, efficient, minimalist and environmentally friendly ETERA heat pump uses geothermal heat from the ground via a vertical or horizontal ground collector, groundwater, etc. It is a suitable solution for both renovations and new buildings.

ETERA is a geothermal heat pump heating system (ground/water or water/water) designed to provide maximum living comfort through an extremely long service life.

Usage

The ETERA heat pump is suitable for underfloor, radiator or convector heating as well as for making domestic hot water. It also enables active and/or passive cooling.

Technology

- **LCL™ – Life Cycle Longevity** – system for exceptional longevity includes the modularity and above-standard components of the heating system, which, with their characteristics and the method of installation in the heat pump, enable an even longer service life.
- **NMS™ – Noise Management System** – extremely low noise system which combines special materials for noise absorption and vibration damping, sophisticated construction and specially developed control.
- **IAH™ – Intelligent Adaptive Heating** – completely adjusts the heat pump's output based on the building's requirements. Special control algorithms modify the temperature of the water in the heating system per the desired room temperature indoor and the current weather outdoor.
- **CDHR™ – Compressor Drive Heat Recovery System** – specially designed cooling and waste heat recovery system of the electronic drive of the compressor makes it possible to exceed 96% of its operating efficiency.
- **Low GWP – Global Warming Potential** – the heat pump uses the advanced refrigerant R452B, which has a whopping 67% less GWP than traditional refrigerants used in heat pumps.
- **MHW™ – Max Hot Water** – heats the entire volume of water available in the integrated DHW tank. The indoor HYDRO B(A) module, which features a 200 l DHW tank, utilizes a special plate heat exchanger and diffuser for hot water stratification to easily heat large quantities of DHW.
- **RCS™ – Remote System Charge** – refills the hydraulic heating system with water to the right working pressure and may be integrated in the HYDRO B(A) module (optional).
- **RASS™ – Remote Administrator System** – remote diagnostics system that can identify malfunctions. Enables remote software updates for flawless operation of the heat pump.
- **EBS™ – Easy Build-in System** – specially designed couplings, modular design of accessories, flexibly extensible pipes, click-opening of the sides and standardization of connections for easy installation in stages and quick connection and start-up.
- **EAS™ – Easy Access System** – easy access to all the main elements of the heat pump from the front, which allows easy maintenance and servicing of the device.
- **BBS™ – Building Blocks System** – modular design of elements in the heat pump with standardized interfaces and dimensions. Basic and additional equipment are compatible with standard elements of heating systems. Components can be easily upgraded and updated using universal sets. The floor area of the heat pump with integrated components always remains the same.
- **CCP™ – Cool Comfort Plus** – active water cooling up to +7 °C as standard. Passive cooling is also possible with optional add on modules.
- **MinimalDesign** – design for permanent home aesthetics and minimal change in the appearance of the room.

NOMENCLATURE

ETERA S-1 HT / HK UF E
ETERA-C M-1 HT / HK 3F

ETERA	The name for a line of heat pumps
ETERA-C	Heat pump for cascade installation
S	Range of heat output: 2-9 kW
M	Range of heat output: 4-12 kW
L	Range of heat output: 6-18 kW
1	Device generation
HT	Temperature of flow outlet up to 67 °C
HK	Heating and cooling
UF	One-phase connection 1 x 230 V or three-phase electrical connection 3 x 400 V
3F	three-phase connection 3 x 400 V
E	Additional electrical heater



ETERA(-C) heat pump

HYDRO B(A) DHW module

CONFIGURATION

The ETERA heat pump is installed in combination with the HYDRO B(A) DHW module or with other heat storage tanks and domestic hot water storage tanks.

The ETERA-C heat pump is installed in combination with selected heat storage tanks and domestic hot water storage tanks.

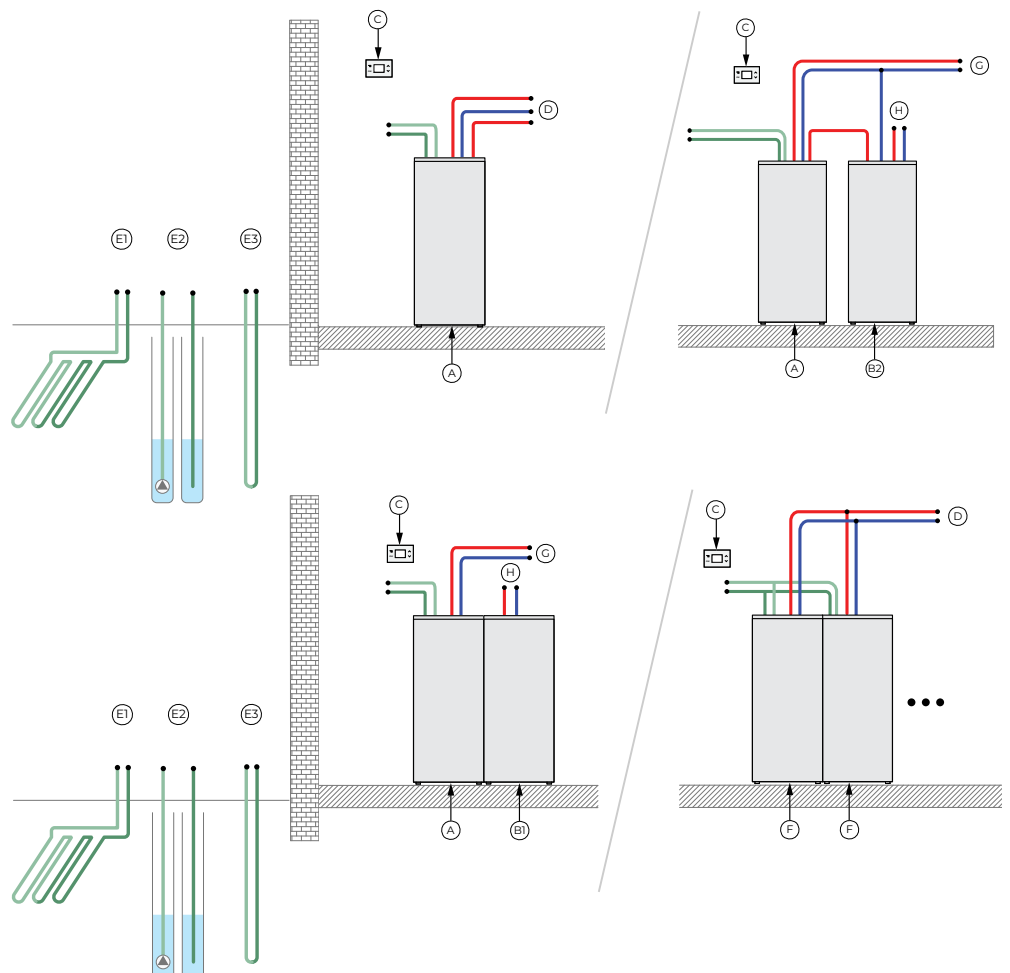

- A ETERA heat pump
- B1 HYDRO B DHW module
- B2 HYDRO BA DHW module
- C KT-2A controller
- D Heat storage and DHW storage tank system
- E1 Horizontal geothermal collector
- E2 Groundwater
- E3 Vertical geothermal collector
- F Heat pump for cascade installation ETERA-C
- G Heating system
- H Hot domestic water

ETERA HEAT PUMP

Version

Compact indoor ground/water or water/water heat pump with integrated regulator and key elements of the heating system.

Model mark

ETERA S-1 HT / HK UF E
ETERA M-1 HT / HK UF E
ETERA M-1 HT / HK 3F E
ETERA L-1 HT / HK 3F E

Description and dimensions

- White powder coated, galvanised sheet metal housing.
- Modular design and removable heat pump module.
- Variable heating capacity.
- Adaptive heating control.
- Special anti-noise design (acoustically insulated housing, damping and vibration management).
- The ETERA heat pump enables: heating, active cooling, domestic water heating, passive cooling (with add on modules MODUL_PASIVA ETERA or MODUL_PIL-PASIVA ETERA).
- Regulation of up to 4 heating loops (2 serially and 2 optional with KSM+ 2 add on module).
- Regulation of additional heaters, such as: electric heater, heating oil boilers, natural gas boilers, pellets, etc.

* In case of MODUL_PIL ETERA, MODUL_PASIVA ETERA or MODUL_PIL-PASIVA ETERA

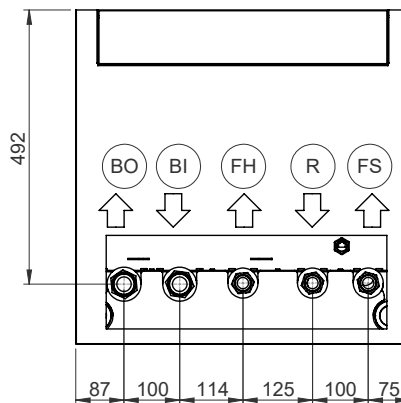
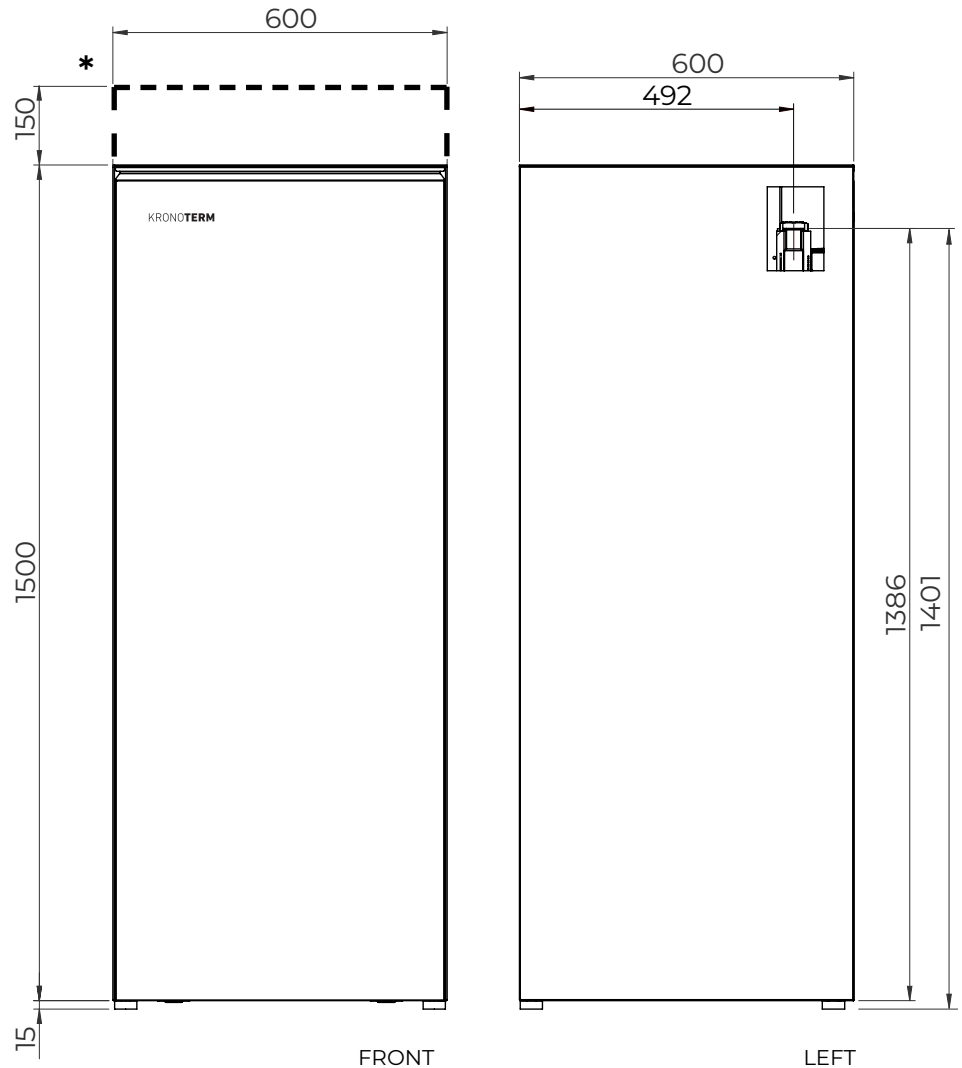

TOP

Key

- BO** Source outlet G 5/4" F
BI Source inlet G 5/4" F
FH Flow heating G 1" F
R Return G 1" F
FS Flow DHW heating G 1" F

ETERA HEAT PUMP

Primary components

- A Heat pump module:
 - Compressor
 - Evaporator
 - Condenser
 - Expansion valve
 - Inverter electronic drive
 - Circulation pump for source
 - Circulation pump for heating
 - Drain valve
 - 4-way valve
 - Filter drier
 - Flow switch at the source
 - Pressure switch
 - High-pressure sensor
 - Low-pressure sensor
 - Temperature sensors
 - Chokes
- B Electrical cabinet with KSM controller, WEB module and space for KSM+ 2 expansion module
- C Protective conduits for cables to the electrical box
- D Internet connection
- E 3-way zone valve
- F Expansion vessel - heating, 18 l
- G Expansion vessel - source, 18 l
- H Safety valve, heating
- I Safety valve, source
- J Flow sensor
- K Pressure sensor, heating
- L Pressure sensor, source
- M Magnetic dirt separator
- N Electrical heater up to 6 kW (3 x 2 kW)

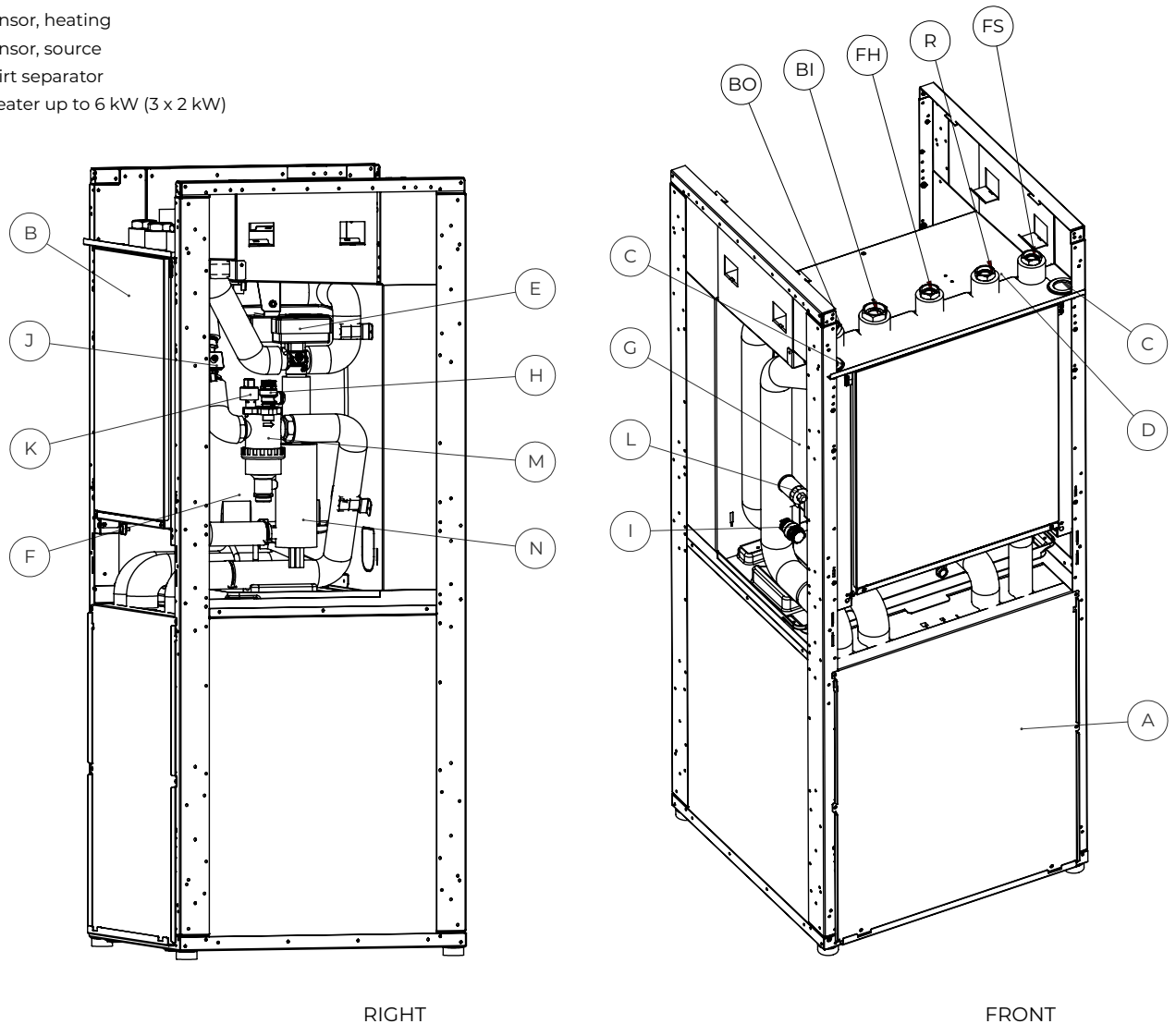

HEAT PUMP ETERA-C

Version

Compact indoor ground/water or water/water heat pump with integrated regulator for cascade installation.

Model mark

ETERA-C M-1 HT / HK 3F
ETERA-C L-1 HT / HK 3F

Description and dimensions

- White powder coated, galvanised sheet metal housing.
- Modular design and removable heat pump module.
- Variable heating capacity.
- Adaptive heating control.
- Special anti-noise design (acoustically insulated housing, damping and vibration management).
- Heat Pump ETERA-C enables: heating, active cooling, domestic water heating (with external 3-way zone valve), passive cooling (in configuration with SET_PASIVA ETERA-C).
Regulation of up to 4 heating loops (2 serially and 2 optional with KSM+ 2 add on module).
- Regulation of additional heaters, such as: electric heater, heating oil boilers, natural gas boilers, pellets, etc.
- ETERA-C is delivered without side panels. These and connecting elements between cascade devices are available as mandatory accessories (see page 18 for more information):
 - KIT_ST ETERA-C
 - KIT_SP ETERA-C
- The device is intended to operate exclusively in cascade solutions. Several ETERA-C devices can be combined in the following way:
 - 2x ETERA-C M
 - 2-4x ETERA-C L

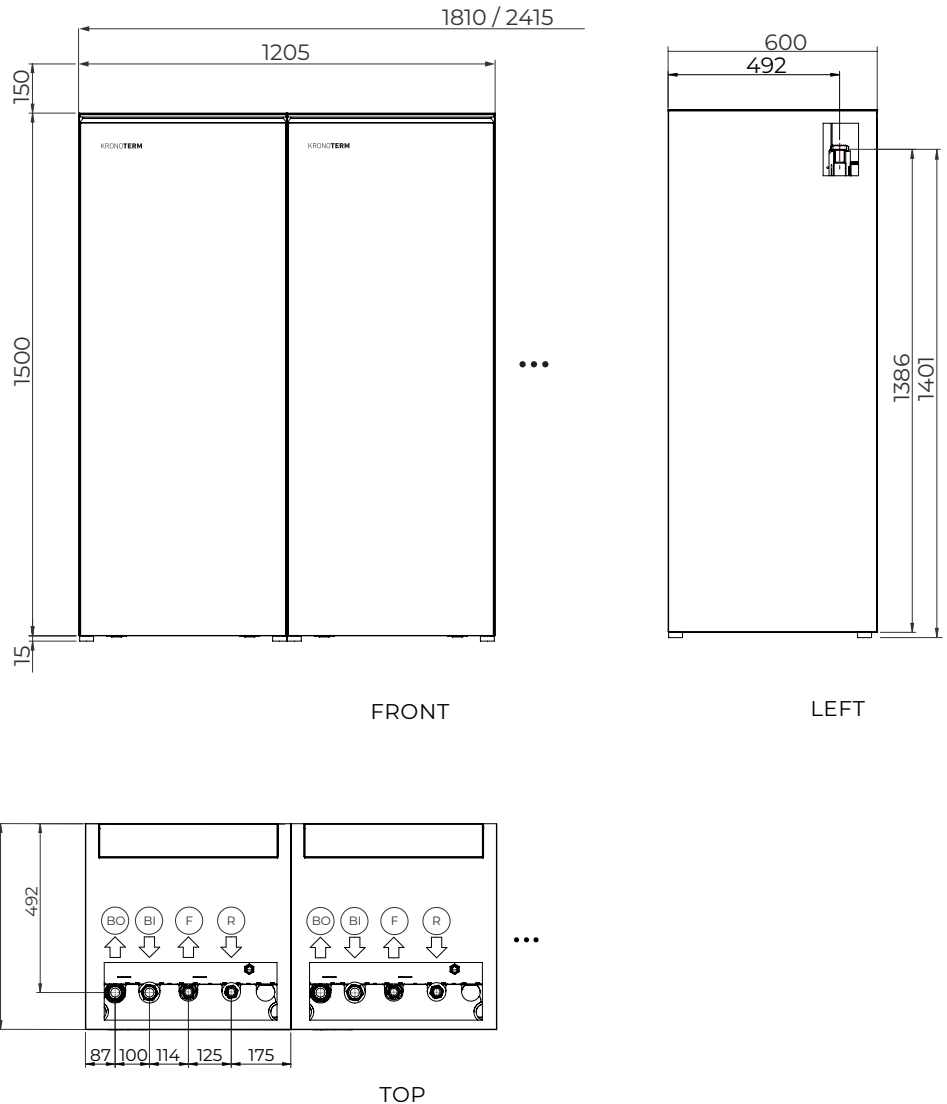

Key

BO Source outlet G 5/4" (F)
BI Source inlet G 5/4" (F)
F Flow G 1" F
R Return G 1" F

HEAT PUMP ETERA-C

Main components

- A Heat pump module:
 - Compressor
 - Evaporator
 - Condenser
 - Expansion valve
 - Inverter electronic drive
 - Circulation pump for source
 - Circulation pump for heating
 - Drain valve
 - 4-way valve
 - Filter drier
 - Flow switch at the source
 - Pressure switch
 - High-pressure sensor
 - Low-pressure sensor
 - Temperature sensors
 - Chokes
- B Electrical box with KSM controller, WEB module and space for KSM+ 2 expansion module
- C Protective conduits for cables to the electrical box
- D Internet connection
- G Expansion vessel - source, 18 l
- J Flow sensor
- M Magnetic dirt separator

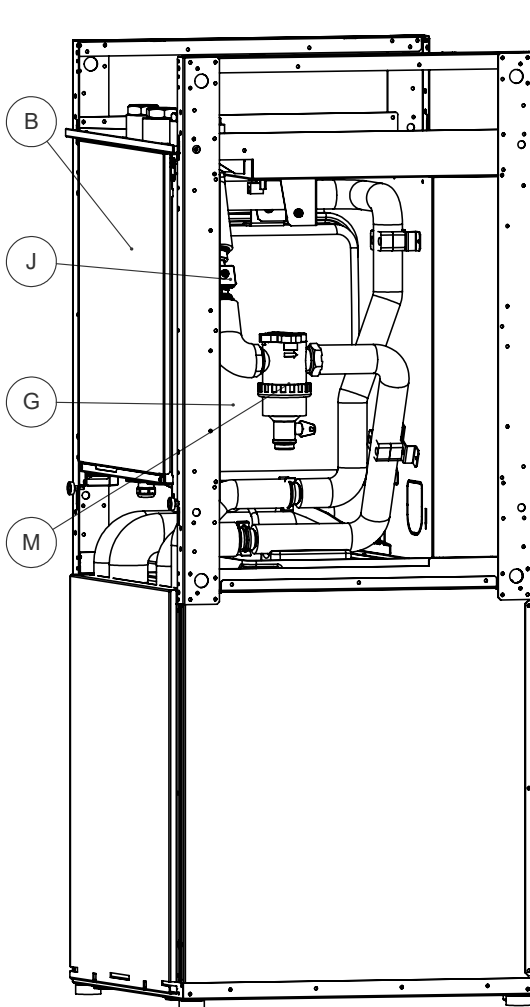

RIGHT

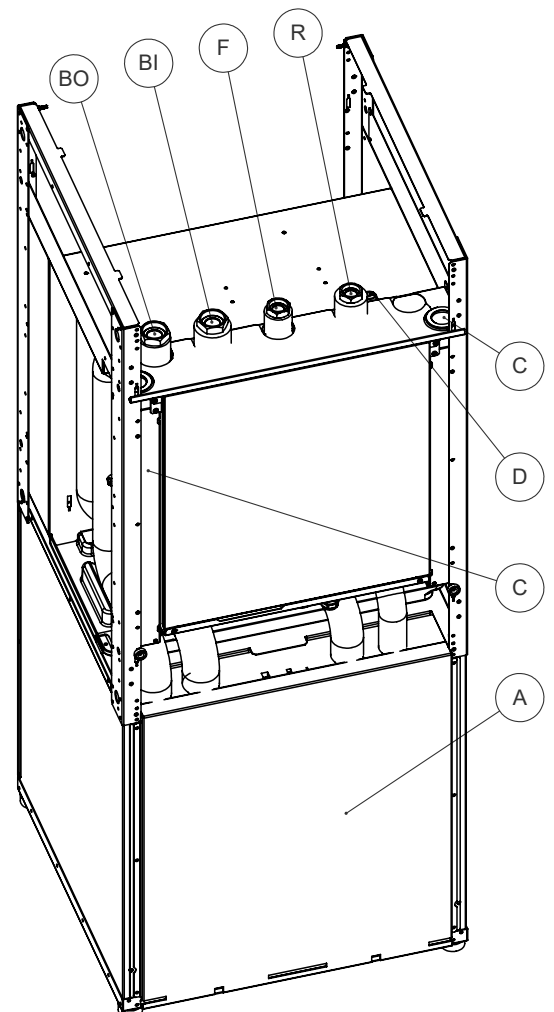

FRONT

HYDRO B DHW MODULE

Version

DHW module.

Model mark

HYDRO B
HYDRO BA

Description and dimensions

- White powder coated, galvanised sheet metal housing.
- Stainless Steel 200 l DHW tank.
- Expansion vessel for DHW.
- Safety valve for DHW.
- Electronic charging of the heating system (optional, with SET_PO HYDRO B equipment).
- Integration of a recirculation DHW pump (optional, with SET_HYDRO B RC equipment).

HYDRO BA is suitable for standalone installation.

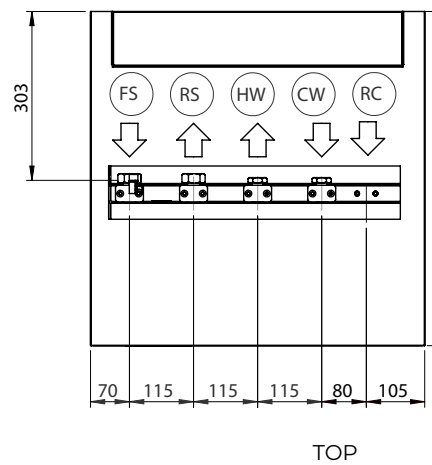
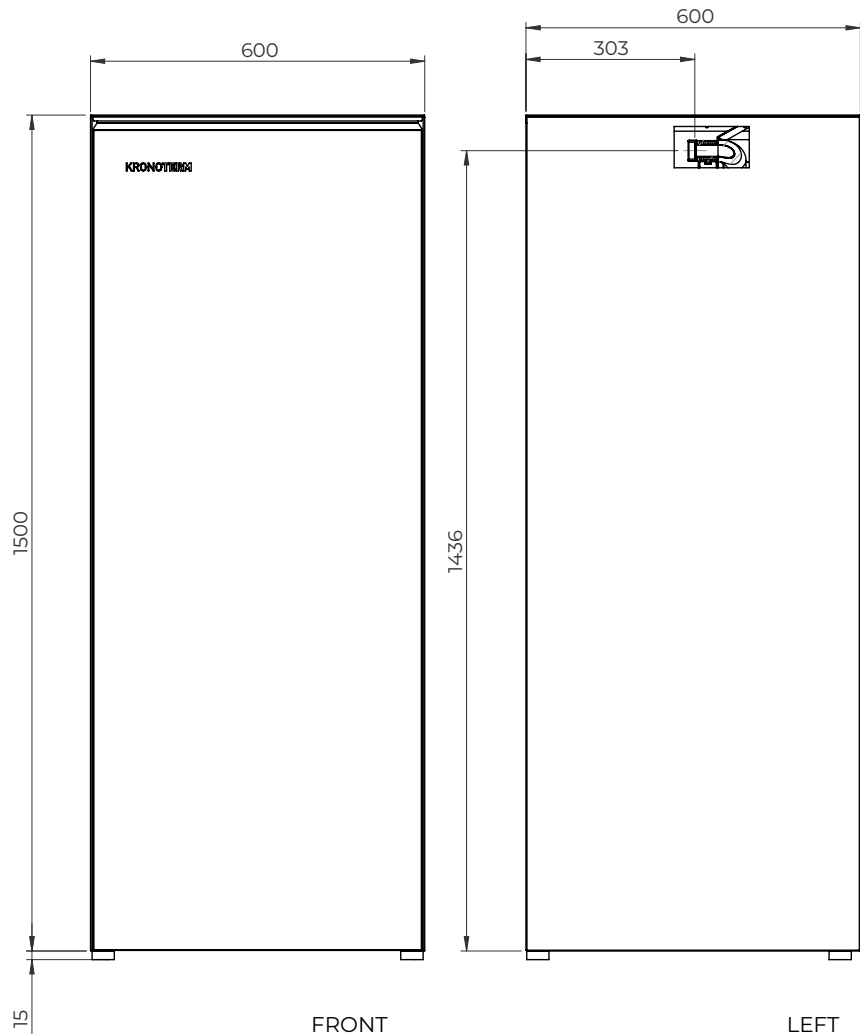

Key

- FS Flow DHW heating G 1" F
 RS Return DHW heating G 1" F
 HW Hot domestic water G 3/4" F
 CW Cold domestic water G 3/4" F
 RC Recirculation domestic hot water (optional)

HYDRO B DHW MODULE

Primary components

- A Stainless steel, 200 l DHW tank
- B Plate heat exchanger for heating domestic water
- C Circulation pump for domestic water heating
- D Expansion vessel for DHW, 8 l
- E Safety valve for domestic water
- F Drain cock
- G Temperature sensor

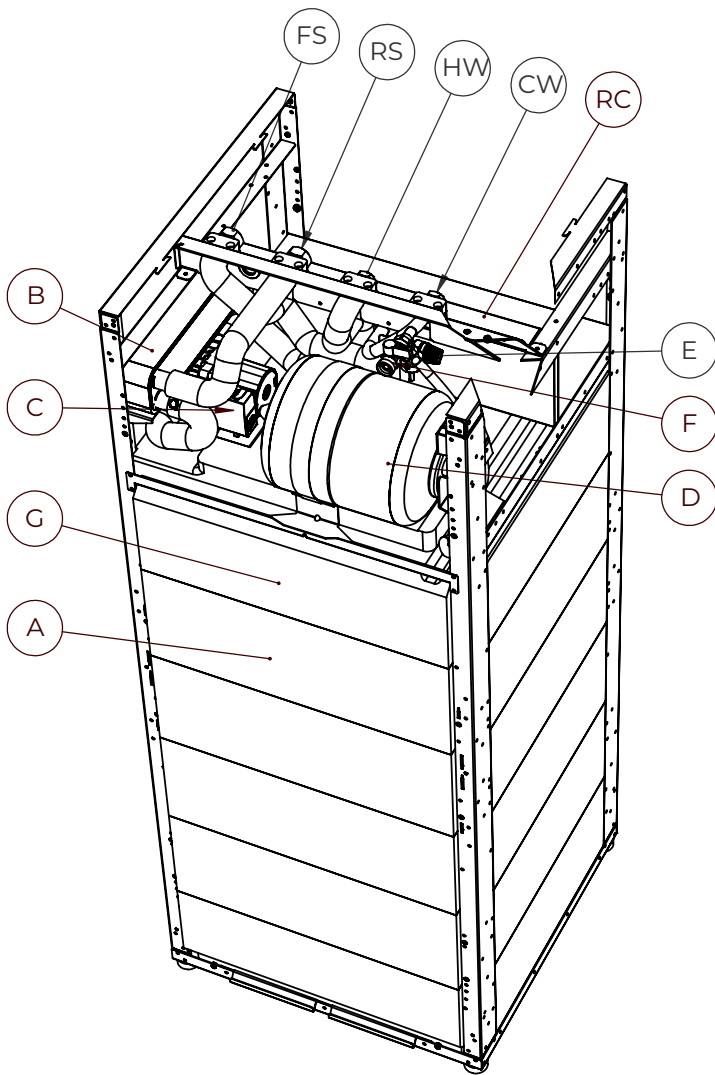

FRONT - RIGHT

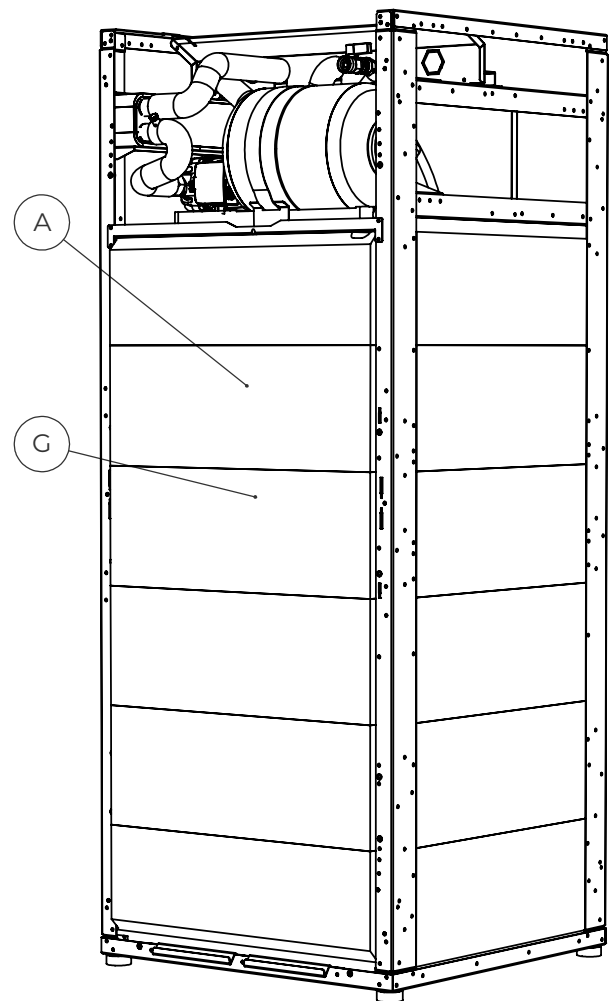

FRONT

HYDRO B DHW MODULE**HYDRO B**

HYDRO B includes a set of connecting pipes for connection to the ETERA heat pump and additional housing elements for integration with the ETERA heat pump.

HYDRO B is always installed on the right side of the ETERA heat pump.

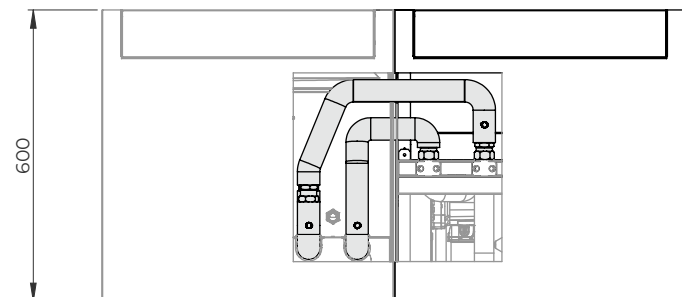
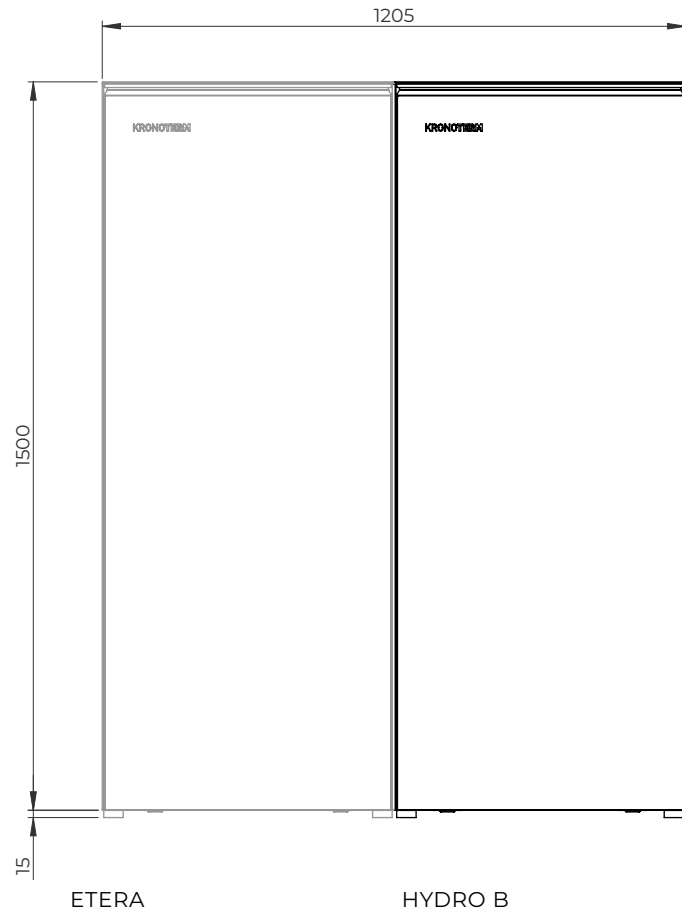

ADDITIONAL MODULES OF THE ETERA SYSTEM

Additional modules for the heat pump

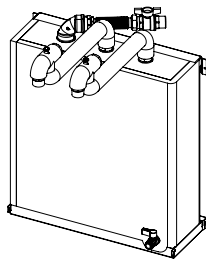
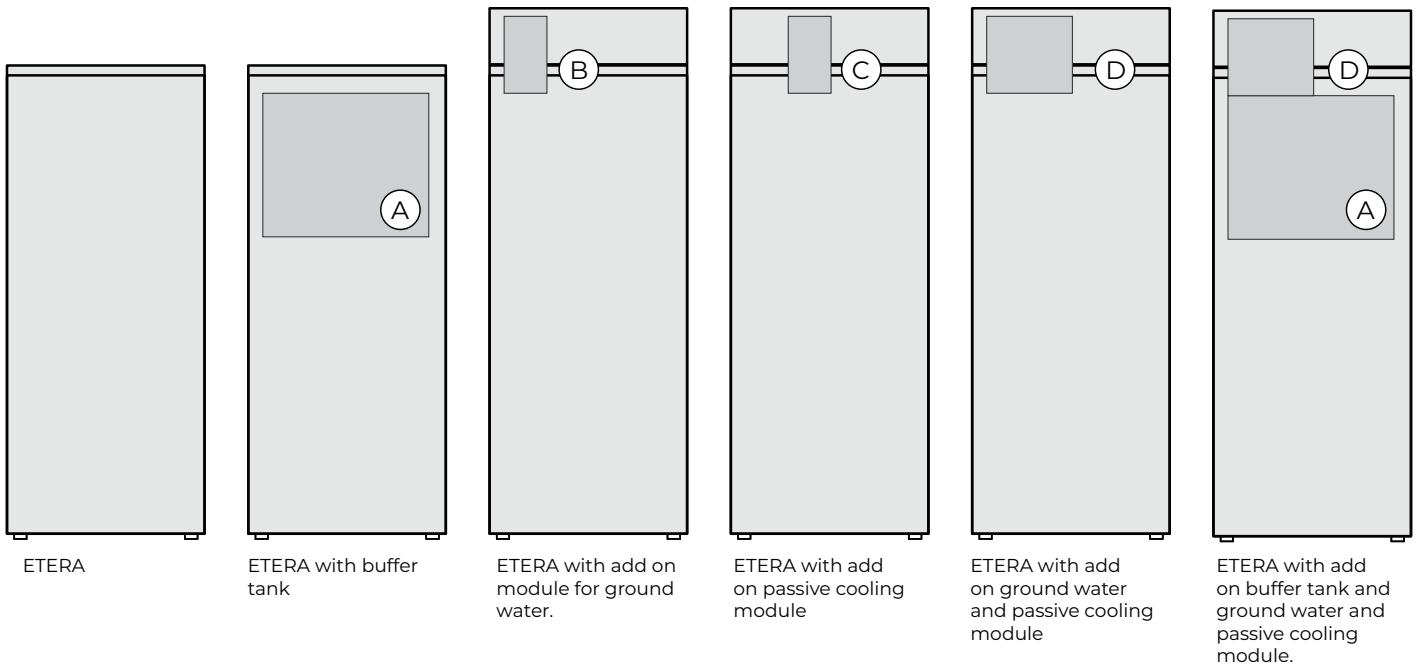

A ZA_P 40 ETERA

Insulated add on 40 l buffer tank.
 Simple mounting to the back of the ETERA heat pump.
 Includes storage tank bracket, drain valve, connecting tubes, flexible tube, ball valve.

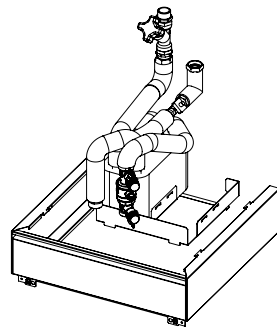

B MODUL_PIL ETERA

Module for using groundwater heat.
 Simple mounting on top of the ETERA heat pump.
 Includes: thermally insulated groundwater heat exchanger, filling mixing valve, groundwater flow sensor, hydraulic balancing valve and add on housing.

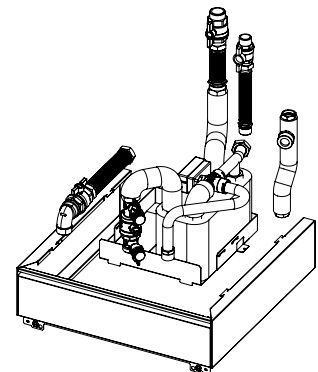

C MODUL_PASIVA ETERA

Module for passive cooling and use of groundwater heat.
 Simple mounting on top of the ETERA heat pump.
 Includes: thermally insulated groundwater and passive cooling heat exchanger, motorised diverter valve, mixing and charging valve, groundwater flow sensor, hydraulic balancing valve, connection kit with tubes, flexible tube, valve, gaskets and add on housing.

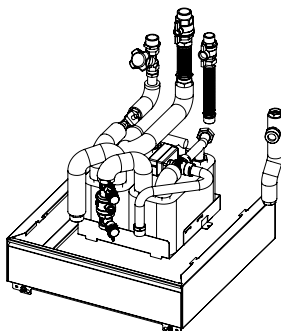

D MODUL_PIL-PASIVA ETERA

Module for passive cooling and use of groundwater heat.
 Simple mounting on top of the ETERA heat pump.
 Includes: thermally insulated groundwater and passive cooling heat exchanger, motorised diverter valve, mixing and charging valve, groundwater flow sensor, hydraulic balancing valve, connection kit with tubes, flexible tube, valve, gaskets and add on housing.

ADDITIONAL MODULES OF THE ETERA SYSTEM

Additional modules for HYDRO B(A)

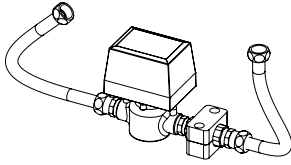

SET_PO HYDRO B

Set for electronic charging of the heating system. Simple mounting to the HYDRO B(A) DHW module.

Includes: motorised shut-off valve, non-return valve, flexible tubes, fill water filter, tube clamp, screws and cable of suitable length for connection to the ETERA.

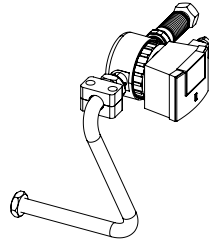

SET_HYDRO B RC

Set with circulation DHW pump. Simple mounting to the HYDRO B(A) DHW module.

Includes: recirculation pump with cable for connection to ETERA and non-return and shut-off valves, tube for connection to HYDRO B(A), tube clamp and flexible tube.

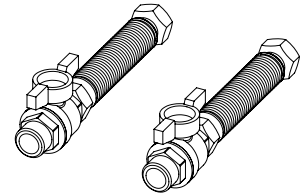

SET_HYDRO B HW-CW

Set of connecting pipes for hot and cold sanitary water.

Includes 2 sets: ball valve, flexible tube gaskets and insulation.

ETERA system connection sets

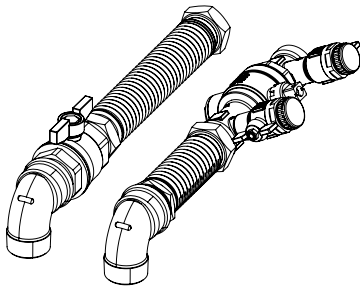

SET_ETERA BO-BI

Set of connecting pipes for the heat source.

Includes: filling valve, ball valve, elbows, 2 flexible tubes, gaskets, insulation.

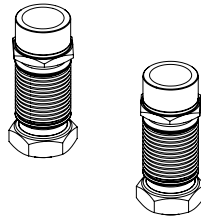

SET_ETERA PIL

Set of connecting pipes for connecting MODUL_PIL ETERA with the groundwater. Includes 2 flexible pipes, gaskets, insulation.

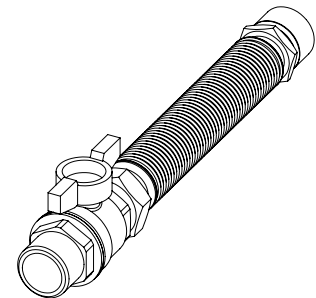

SET_ETERA FH-R

Set of connecting pipes for the heating system.

Includes: ball valve, flexible tube, gaskets and insulation.

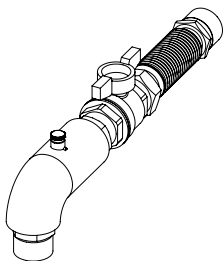







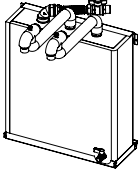
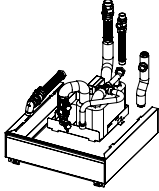
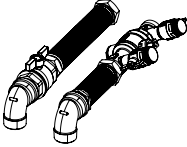
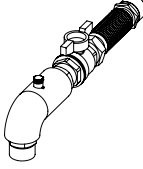

SET_ETERA FH-R-FS

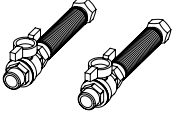
Set of connecting pipes for the heating system and domestic water heating.



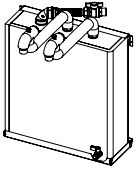
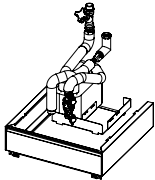
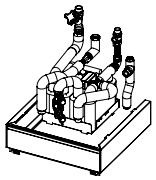
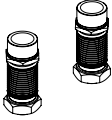
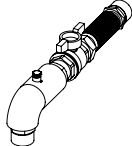

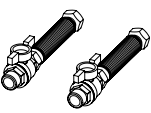
Includes: ball valve, elbow and flexible tube, gaskets and insulation.

ADDITIONAL MODULES OF THE ETERA SYSTEM

		ADDITIONAL MODULES		SET OF CONNECTING PIPES (OPTIONAL)			
		Buffer tank	Passive cooling	Heat source	Heating system		Sanitary water
		ZA_P 40 ETERA	MODUL_PASIVA ETERA	SET_ETERA BO-BI	SET_ETERA FH-R-FS	SET_ETERA FH-R	SET_HYDRO B HW-CW
BRINE/WATER							
1				1x	1x	1x	1x
2		✓		1x		1x	1x
3			✓			1x	1x
4	ETERA + HYDRO B(A)	✓	✓				1x
5				1x	3x		
6		✓		1x	1x	2x	
7			✓		2x		
8	ETERA	✓	✓		1x	1x	

		ADDITIONAL MODULES			SET OF CONNECTING PIPES (OPTIONAL)			
		Buffer tank	Groundwater usage	Passive groundwater cooling	Heat source	Heating system		Sanitary water
		ZA_P 40 ETERA	MODUL_PIL ETERA	MODUL_PIL-PASIVA ETERA	SET_ETERA PIL	SET_ETERA FH-R-FS	SET_ETERA FH-R	SET_HYDRO B HW-CW
WATER/WATER								
1			✓		1x	1x	1x	1x
2		✓	✓		1x		1x	1x
3				✓	1x		1x	1x
4	ETERA + HYDRO B(A)	✓		✓	1x			1x
5			✓		1x	3x		
6		✓	✓		1x	1x	2x	
7				✓	1x	2x		
8	ETERA	✓		✓	1x	1x	1x	



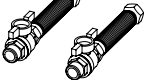

CONFIGURATION MATRIX HYDRO BA

		SET OF CONNECTING PIPES (OPTIONAL)			
		Heat source	Heating system		Sanitary water
HYDRO BA		SET_ETERA PIL	SET_ETERA FH-R-FS	SET_ETERA FH-R	SET_HYDRO B HW-CW
1					
	HYDRO BA			2x	1x

1:1 SCALE TEMPLATE FOR THE CONNECTION PREPARATION*Templates supplied with the equipment*

ETERA	E1, E1Z
MODUL_PIL ETERA	E2, E2Z
MODUL_PASIVA ETERA	E3, E3Z
MODUL_PIL-PASIVA ETERA	E4, E4Z
HYDRO B	B1, B1Z
HYDRO BA	BA
ETERA-C	E1C

Suitable template selection

	ZA_P 40 ETERA	MODUL_PIL ETERA	MODUL_PASIVA ETERA	MODUL_PIL-PASIVA ETERA	TEMPLATE
ETERA+ HYDRO B 	✓				E1 + B1
					E1Z + B1Z
		✓			E2 + B1
	✓	✓			E2Z + B1Z
				✓	E3 + B1
	✓			✓	E3Z + B1Z
	✓				✓
				✓	E4Z + B1Z
ETERA 	✓				E1
					E1Z
		✓			E2
	✓	✓			E2Z
				✓	E3
	✓			✓	E3Z
					✓
✓				✓	E4Z
ETERA-C 					E1C
HYDRO BA 					BA

ADDITIONAL EQUIPMENT ETERA-C

Mandatory accessories

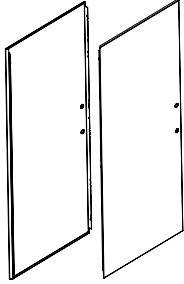

KIT_ST ETERA-C

Side panels for ETERA(-C)

Includes: side panels and screws

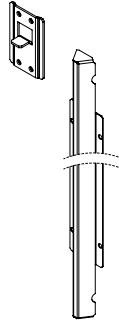

KIT_SP ETERA-C

Connecting elements for the cascade assembly of ETERA-C

Includes: 1x ETERA-C spacer, 1x connecting rail and screws.

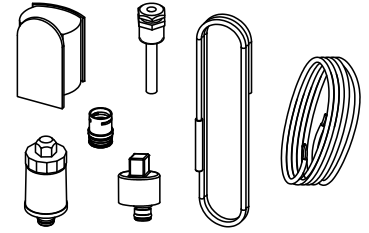

KIT_KS ETERA-C

A set of sensors and parts for establishing cascade operation.

Includes: 2x sensor sleeve, 4x temperature sensor, 1x external temperature sensor, 1x pressure sensor (source), 1x pressure sensor (heating system) with adapter for installation, communication cables, labels for marking the cascade.

Connection set ETERA-C

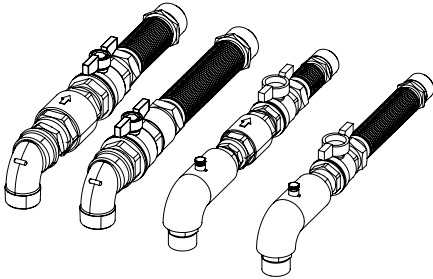

SET_ETERA-C BO-BI-F-R

Connection set for the heat source and the heating system.

Includes: elbows, 2x shut-off valve, 2x non-return valve, flexible pipes, gaskets and insulation.

Additional modules for ETERA-C

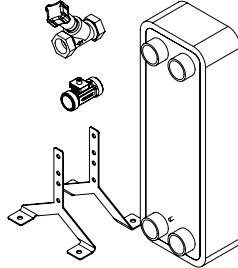

SET_PIL ETERA-C

A set of parts for the usage of groundwater heat for a system with a cascade design.

Available in 2 sizes:
SET_PIL ETERA-C 2M 2L
SET_PIL ETERA-C 3L 4L

Includes: insulated heat exchanger with bracket, flow sensor and throttle valve.

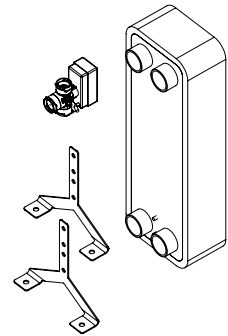

SET_PASIVA ETERA-C

A set of parts for passive cooling in a system with ETERA-C.

Includes: insulated heat exchanger with bracket, 3-way zone valve, PWM-R relay module and cables for PWM-R module.

Equipment for the heating system

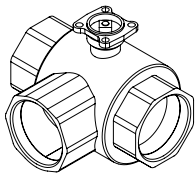

TVE_DN

3-way zone valve



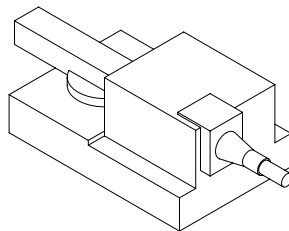

Available in 3 sizes:
TPV_DN32/15 B
TPV_DN40/47 B
TPV_DN50/75 B





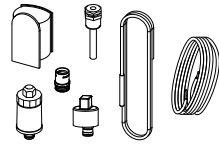
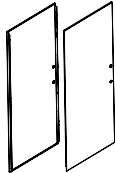
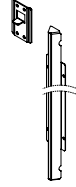
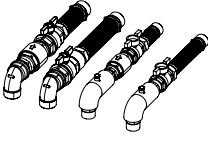

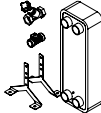
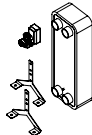
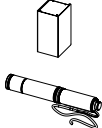

EMP_SR230A

Electro-motor drive for 3-way zone valve.

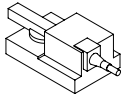
ADDITIONAL EQUIPMENT ETERA-C

		MANDATORY ACCESSORIES			CONNECTION SET
		Cascade operation elements	Side panels	Connecting elements	Heat source & Heating system
		KIT_KS ETERA-C	KIT_ST ETERA-C	KIT_SP ETERA-C	SET_ETERA-C BO-BI-F-R
					
ETERA-C M		1x	1x	1x	2x
ETERA-C L		1x	1x	1x	2x
		1x	1x	2x	3x
		1x	1x	3x	4x

		ADDITIONAL MODULES					
		Buffer tank	Groundwater usage	Passive cooling	Submersible pump with control module	3-way zone valve	Electro-motor drive for 3-way zone valve
							
ETERA-C M		ZA_WPPS 300	SET_PIL ETERA-C 2M 2L	SET_PASIVA ETERA-C	KIT_PC ETERA-C 2M	TVE_DN32/15 B	EMP_SR230A
ETERA-C L		ZA_WPPS 300	SET_PIL ETERA-C 2M 2L	SET_PASIVA ETERA-C	KIT_PC ETERA-C 2L	TVE_DN40/47 B	EMP_SR230A
		ZA_WPPS 400	SET_PIL ETERA-C 3L 4L	SET_PASIVA ETERA-C	KIT_PC ETERA-C 3L	TVE_DN40/47 B	EMP_SR230A
		ZA_WPPS 500	SET_PIL ETERA-C 3L 4L	SET_PASIVA ETERA-C	KIT_PC ETERA-C 4L	TVE_DN50/75 B	EMP_SR230A

ELECTRO MODULES

MODULE HYDRO PWM-R

Model mark
HYDRO PWM-R

Description

Relay module for regulating circulation pumps without PWM signal. Simple integration into the heat pump module by connecting to the KSM controller and KSM+ expansion module.

Functional characteristics

- The relay module allows any circulation pump for heating loops to be connected to the system, as the PWM-R module converts the continuous signal into an ON/OFF signal.
- Solution for controlling existing circulation pumps without a continuous control input.
- Solution for ON/OFF control of submersible pumps.

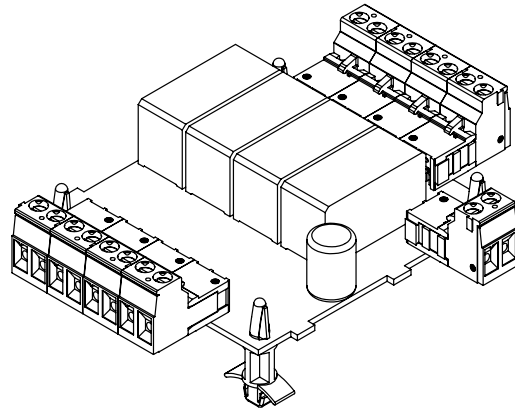

HYDRO PWM-R: included spacers and cable for connection to KSM+

KIT FOR UPGRADING A 2-WIRE CABLE

Model mark
KIT_P2P KT-1/KT-2A

Description

Kit for connecting KT-2A or KT-1 to a 2-wire cable. One part is installed into the wall electrical box beneath KT-2A or KT-1, and the other part is installed into the heat pump.

Functional characteristics

- Allows the use of the existing 2-wire cable for connecting KT-2A.

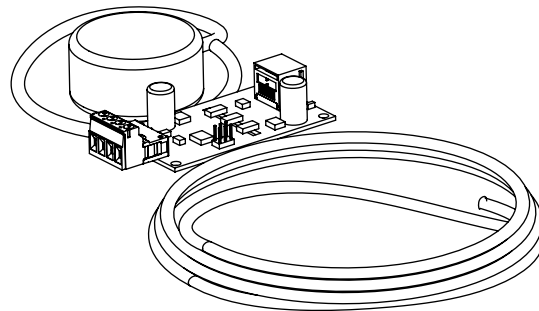

GROUNDWATER PUMPING KIT

Model mark
KIT_PC ETERA S M, KIT_PC ETERA L

For cascade systems:
KIT_PC ETERA-C 2 M,
KIT_PC ETERA-C 2 L,
KIT_PC ETERA-C 3 L,
KIT_PC ETERA-C 4 L

Description

Includes: submersible pump with cable and wall-mounted electrical cabinet with frequency converter.

Functional characteristics

- Enables pumping of groundwater at an adjustable pump speed to minimize electricity consumption.

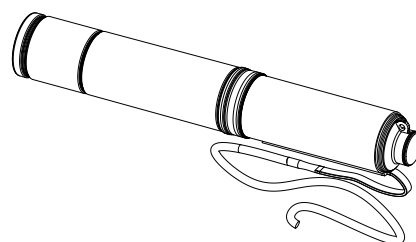
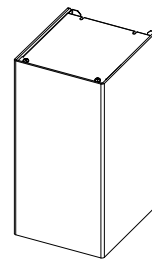

BASIC KSM REGULATOR

Model mark

KSM (KRONOTERM System Manager)

Description

Basic heat pump and heating system regulator.
Control via the KT-2A controller or the
CLOUD.KRONOTERM mobile/web application.

Functional characteristics

- Heat pump control.
- Control of additional heat generators (gas, oil or pellet boiler).
- Submersible pump control.
- Circulation control.
- Domestic water heating.
- Domestic water thermal disinfection.
- Adaptive weather control of individual loops based on outdoor and room temperature (requirement: accessory KT-1 or KT-2A).
- Active cooling.
- Groundwater flow measurement.
- Usage of excess energy from the PV module (PV program).
- Screed-drying program.
- Control functions for:
 - 1x direct loop (radiators/convectors/in-floor heating);
 - 1x direct or mixing loop (radiators/convectors/in-floor heating);
 - room temperature regulation with KT-1 and KT-2A;
 - daily and weekly schedules.
- WEB module for internet connection (RJ45 connection – Ethernet).
- BMS connection via MODBUS RS485 protocol.
- Smart-grid ready (SG ready).

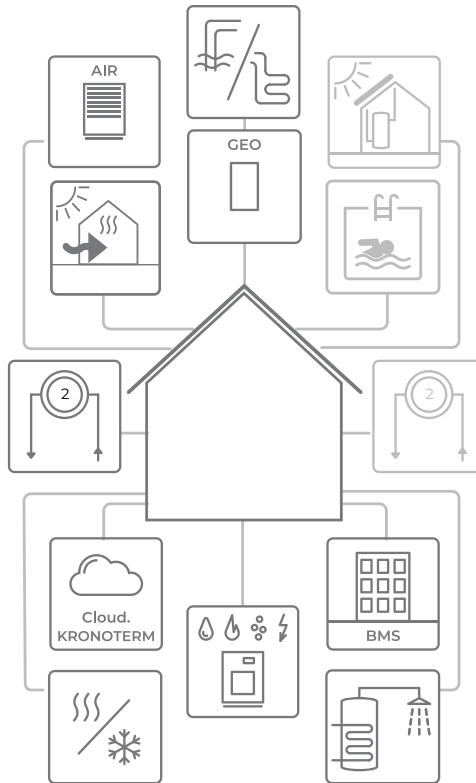

KSM+ 2 EXPANSION MODULE

Model mark

KSM+ (KRONOTERM System Manager+)

Description

Expansion module for upgrading the basic regulator.
Integration in the ETERA heat pump. Possible
installation of one expansion module.

Functional characteristics

- Managing 2 additional heating loops (direct or mixed).
- Utilizing the heat of sunlight collectors.
- Utilizing the heat of biomass boilers (wood chips).
- Pool heating.
- Pool heating with sunlight collectors.

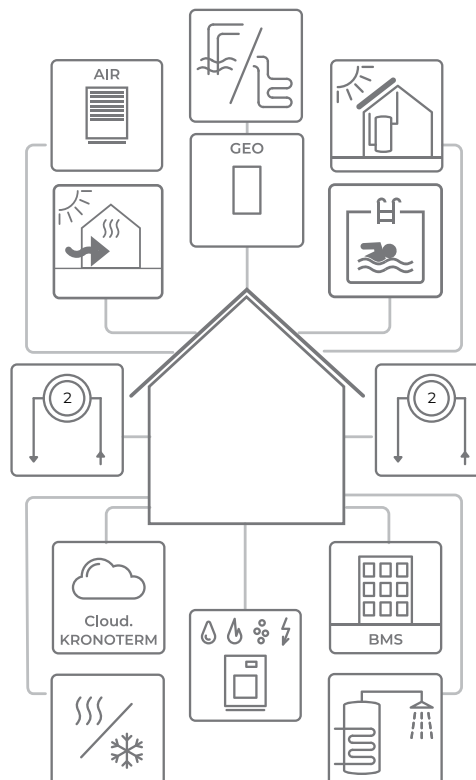

CONTROL EQUIPMENT

KT-2A CONTROLLER

Model mark

KT-2A

Description and dimensions

To operate the heat pump, DHW module and heating system.

Functional characteristics

- To operate the heat pump modules and heating system.
- Control and setting of all heating/cooling loops.
- Control and setting of DHW.
- Control and setting of room temperature.
- Operating status indicators.
- Service access and troubleshooting.
- Ambient temperature measurement and display.
- Weather forecast.
- Night mode.
- Measurement accuracy: 0.1°C.
- Setting step: 0.1°C.
- Modbus RS485 cable connection.
- Color LCD display and capacitive keys.
- Depending on the settings, the KT-2A controller can be used in three operating modes: as a thermostat, controller of the heat pump and the heating system, thermostat and controller of the heat pump and the heating system.

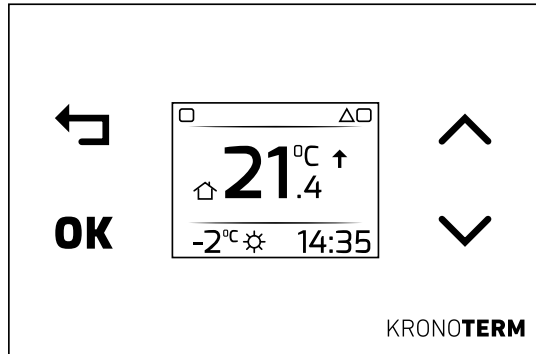

KT-2A controller (W: 122, H: 80, D: 8.6)

TERMOSTAT KT-1

Model mark

KT-1

Description and dimensions

Control and setting of room temperature and operation of each individual heating/cooling loop.

Functional characteristics

- Room temperature measurement and display.
- Room temperature setting.
- Operation mode of the heating loop (OFF/ON/AUTO).
- Night mode.
- Measurement accuracy: 0.1°C.
- Setting step: 0.5 °C.
- Setting range: 17-27°C.
- Modbus RS485 cable connection.
- LED illumination and capacitive keys.

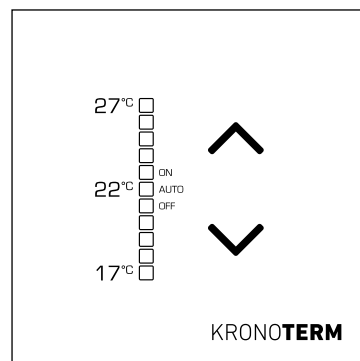

KT-1 thermostat (W: 80, H: 80, D: 8.6)

CLOUD.KRONOTERM

Description

CLOUD.KRONOTERM gives you oversight and control over your heat pump, its heating loops, and its consumption and operational costs.

The only condition is that your appliance be connected to the internet.

Recording all events and over 30 operational parameters gives the support team a comprehensive overview and instantaneous diagnostics in the event of a malfunction. All of the data collected are used for permanent improvements which automatically get fed into the appliance, increasing your comfort and lowering operational costs.

CLOUD.KRONOTERM makes your already installed appliance smarter and better.

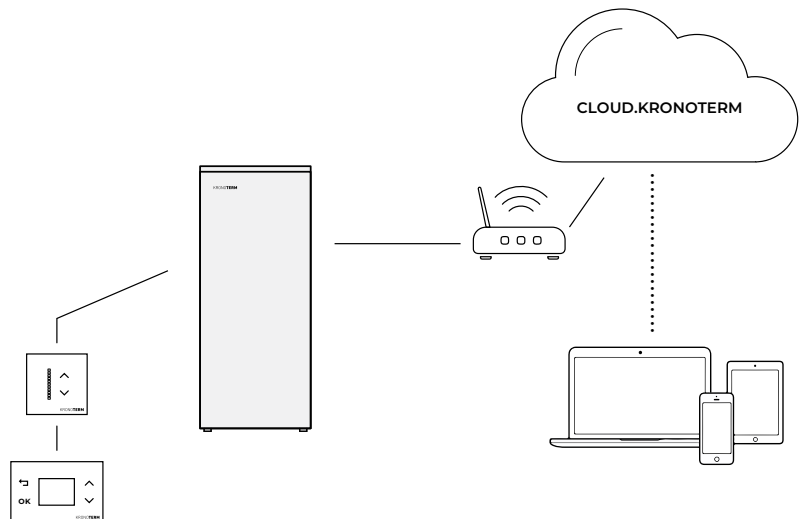

Functional characteristics

- The CLOUD.KRONOTERM mobile or web application is a clear and transparent graphic interface, with which you can easily set the desired room or domestic water temperatures.
- Temperature setting step: 0.1°C.
- In the app, user can also set:
 - daily and weekly schedule;
 - heat pump operation mode;
 - screed drying;
 - pool heating;
 - anti-legionella program;
 - holiday program, ...
- In the application, users monitor indicators such as:
 - heat pump heating power;
 - operating hours of heating, cooling, passive cooling, additional heater 1 and/or additional heater 2 and outdoor temperature;
 - theoretical electricity consumption energy for individual components of the heating system;
 - information, warnings and alarms about the operation of the heat pump.
- The app makes it easy for the user to connect to remote diagnostics support.



Test of the mobile app demo version:

USER NAME: demo1

PASSWORD: demo1



Test of the mobile app demo version HOME.CLOUD:

USER NAME: demo1

PASSWORD: demo1



TECHNICAL DATA

APPLIANCE	Unit	ETERA S		ETERA M		ETERA L	
		UF	UF	3F	3F		
Add on modules		HYDRO B(A), ZA_P40 ETERA, MODUL_PIL ETERA, MODUL_PASIVA ETERA, MODUL_PIL-PASIVA ETERA					

VERSION

	ETERA S	ETERA M	ETERA L
Heat source	geothermal energy (collector/groundwater)	geothermal energy (collector/groundwater)	geothermal energy (collector/groundwater)
Heat sink	water	water	water
Controller	KSM	KSM	KSM
Heat pump location	indoor	indoor	indoor
Controller position	integrated in the heat pump unit	integrated in the heat pump unit	integrated in the heat pump unit
Compressor	1 X scroll with variable speed	1 X scroll with variable speed	1 X scroll with variable speed
Compressor drive	DC inverter	DC inverter	DC inverter
Circulation pump at the source	integrated	integrated	integrated
Circulation pump, secondary	integrated	integrated	integrated
Electrical heater	1 x 2 kW (1F) 1 x 2 kW (3F)	1 x 2 kW (1F) 2 x 2 kW (3F)	3 x 2 kW (3F)
Zone valve	integrated	integrated	integrated
Water flow sensor, sink	integrated	integrated	integrated
Flow switch, source	integrated	integrated	integrated
Pressure sensor, sink	integrated	integrated	integrated
Pressure sensor, source	integrated	integrated	integrated
Safety valve, heating system	integrated	integrated	integrated
Safety valve, source	integrated	integrated	integrated
Expansion vessel, heating system	integrated	integrated	integrated
Expansion vessel, source	integrated	integrated	integrated

ELECTRICAL DATA*

ELECTRICAL DATA 1F		UF	UF		
Rated voltage	V, Hz	~ 230 V; 50 Hz	~ 230 V; 50 Hz	/	/
El. heater	kW	1 x 2 ~ 230 V	1 x 2 ~ 230 V	/	/
Max. operating current	A	29,7	35,2	/	/
Max. electric capacity	kW	6,6	7,8	/	/
Fuses	A	1 x 32	1 x 40	/	/
Power supply cable**	mm ²	3 x 6	3 x 10	/	/

ELECTRICAL DATA 3F		UF	UF	3F	3F
Rated voltage	V, Hz	3N~400V; 50Hz	3N~400V; 50Hz	3N~400V; 50Hz	3N~400V; 50Hz
El. heater	kW	1 x 2 kW ~ 230 V	2 x 2 kW ~ 230 V	2 x 2 kW ~ 230 V	3 x 2 kW ~ 230 V
Max. operating current	A	16,6	21,9	21,3	24,2
Max. electric capacity	kW	6,6	9,8	10,2	14,3
Fuses	A	3 x 16	3 x 25	3 x 20	3 x 25
Power supply cable**	mm ²	5 x 2,5	5 x 4	5 x 2,5	5 x 4

COMMUNICATION

	ETERA S	ETERA M	ETERA L
Connection to BMS	MODBUS protocol (UTP cable connection RJ45) RS 485	MODBUS protocol (UTP cable connection RJ45) RS 485	MODBUS protocol (UTP cable connection RJ45) RS 485
Connection to the internet	FTP cable - RJ45 connection - Ethernet	FTP cable - RJ45 connection - Ethernet	FTP cable - RJ45 connection - Ethernet

* For the system's connection power, power cables, and fuse dimensions, see the instructions on preparing for installation.

** Tu = 0°C/Tk = 60°C/f = 120 Hz

TECHNICAL DATA

APPLIANCE	Unit	ETERA-C M	ETERA-C L
VERSION			
Heat source		geothermal energy (collector/groundwater)	" geothermal energy (collector/groundwater)"
Heat sink		water	water
Controller		KSM	KSM
Heat pump location		indoor	indoor
Controller position		Integrated in the heat pump	Integrated in the heat pump
Compressor		1 x scroll with variable speed	1 x scroll with variable speed
Compressor drive		DC inverter	DC inverter
Circulation pump at the source		integrated	integrated
Circulation pump, secondary		integrated	integrated
Electrical heater		/	/
Zone valve		/	/
Water flow sensor, sink		integrated	integrated
Flow switch, source		integrated	integrated
Pressure sensor, sink		/	/
Pressure sensor, source		/	/
Safety valve, heating system		/	/
Safety valve, source		/	/
Expansion vessel, heating system		/	/
Expansion vessel, source		integrated	integrated

ELECTRICAL DATA*

ELECTRICAL DATA 3F		3F	3F
Rated voltage	V, Hz	3N~400V; 50Hz	3N~400V; 50Hz
El. heater	kW	/	/
Max. operating current	A	12,5	15,4
Max. electric capacity	kW	6,17	8,3
Fuses	A	3 x 16	3 x 16
Power supply cable**	mm ²	5 x 2,5	5 x 2,5

COMMUNICATION

Connection to BMS	MODBUS protocol (UTP cable connection RJ45) RS 485	MODBUS protocol (UTP cable connection RJ45) RS 485
Connection to the internet	FTP cable - RJ45 connection - Ethernet	FTP cable - RJ45 connection - Ethernet

** For the system's connection power, power cables, and fuse dimensions, see the instructions on preparing for installation.

** Tu = 0°C/Tk = 60°C/f = 120 Hz"

TECHNICAL DATA

APPLIANCE	Unit	ETERA S UF	ETERA M UF	ETERA(-C) M 3F	ETERA(-C) L 3F
COOLING SYSTEM					
Refrigerant - type		R-452B		R-452B	R-452B
Refrigerant - industrial designation		HFC - 452B (HFC -32, HFO-1234yf, HFC-125; 67%/7%/26%)	HFC - 452B (HFC -32, HFO-1234yf, HFC-125; 67%/7%/26%)		HFC - 452B (HFC -32, HFO-1234yf, HFC-125; 67%/7%/26%)
GWP (global warming potential) refrigerants		676		676	676
Refrigerant - quantity	kg	1,1		1,3	1,7

GROUND / WATER

PRIMARY SIDE (HEAT SOURCE) – BRINE

INTEGRATED CIRCULATION PUMP					
Rated flow (min.-max.)*	m ³ /h	1,4 - 2,15	2,3 - 2,85	2,3 - 2,85	2,3 - 4,4
Max. available external pressure drop**	kPa	43,6	59,3	59,3	32,0
Brine Pressure (min. - max.)	bar	0,5 - 3,0	0,5 - 3,0	0,5 - 3,0	0,5 - 3,0

SECONDARY SIDE (HEAT SINK) – WATER

INTEGRATED CIRCULATION PUMP					
Rated flow (min.-max.)***	m ³ /h	0,8 - 1,55	1,2 - 2,1	1,2 - 2,1	1,7 - 3,1
Max. available pressure drop	kPa	47,1	16,6	16,6	13,8

WATER / WATER

PRIMARY SIDE (HEAT SOURCE) – GROUND-WATER

INTEGRATED CIRCULATION PUMP					
Rated flow (min.-max.)*	m ³ /h	1,4 - 2,15	2,3 - 2,85	2,3 - 2,85	2,3 - 4,4
Min. pressure drop on MODUL_PIL ETERA**	kPa	18,7	34	34 (ETERA M)	80,1 (ETERA L)
Min. pressure drop on SET_PIL ETERA-C**				18 (ETERA-C M)	42,2 (ETERA-C L)
Water Pressure (min. - max.)	bar	0,5 - 3,0	0,5 - 3,0	0,5 - 3,0	0,5 - 3,0

SECONDARY SIDE (HEAT SINK) – WATER

INTEGRATED CIRCULATION PUMP					
Rated flow (min.-max.)***	m ³ /h	0,8 - 1,55	1,2 - 2,1	1,2 - 2,1	1,7 - 3,1
Max. available pressure drop	kPa	47,1	16,6	16,6	13,8

*for water/water inlet T of water 10°C for ground / water: inlet T of the 30% ethylene glycol solution in the appliance is 0°C

** at rated flow, max.

*** at maximum heating power and dT 5K according to EN 14511 (flow from - to)

VOLUME

Buffer tank (optional)****	l	40		40	40
Heat loss Q _{st} at 55°C	kWh/ 24 h	1,2		1,2	1,2
Heat loss Q _{st} at 35 °C	kWh/ 24 h	0,335		0,335	0,335

HEATING

Operating range - min/max temperature of medium	°C	-10 / 15		-10 / 15	-10 / 15
---	----	----------	--	----------	----------

COOLING

Operating range - min/max temperature of medium	°C	5 / 25		5 / 25	5 / 25
---	----	--------	--	--------	--------

DIMENSIONS AND MASS - TRANSPORT

Dimensions (W x H x D)	mm	700 x 1655 x 625		700 x 1655 x 625	700 x 1655 x 625
Mass	kg	200,5	219,5	219,5 214 (ETERA-C)	228,5 223 (ETERA-C)

DIMENSIONS AND MASS - NET

Dimensions (W x H x D)	mm	600 x 1515 x 600		600 x 1515 x 600	600 x 1515 x 600
Mass	kg	189	208	208	217

**** does not apply to ETERA-C

DHW MODULE

HYDRO B

HYDRO BA

ELECTRICAL DATA

Rated voltage/Frequency		~ 230 V; 50 Hz	~ 230 V; 50 Hz
Max. operating current	A	0,38	0,38
Max. electric power	kW	0,08	0,08

VERSION

Volume	l	200	200
Temperature loss Qst according to EN 12897	kWh/24h	0,9	0,9
Material		stainless steel	stainless steel
Quantity of sanitary hot water (40 °C)	l	295	295

DIMENSIONS AND WEIGHT - TRANSPORT

Dimensions (W x H x D)	mm	700 x 1655x 625	700 x 1655 x 625
Mass	kg	88	90

DIMENSIONS AND WEIGHT - NET

Dimensions (W x H x D)	mm	600 x 1515 x 600	600 x 1515 x 600
Mass	kg	74	76

SCOPE OF DELIVERY

Set of connecting pipes for connection to the ETERA heat pump		yes	no
Additional housing elements for integration with the ETERA heat pump		yes	no

SOUND

APPLIANCE

Unit

ETERA S

ETERA(-C) M

ETERA(-C) L

SOUND ACCORDING TO EN 12102 AT THE CONDITION OF B0W35

THE DECLARED SOUND POWER ON THE ECOLABEL ENERGY LABEL

Sound power	dB (A)	32	34	35
Sound pressure level at the distance of 1 m	dB (A)	24	26	27

SOUND POWER IN OPTIMAL MODE

Sound power	dB (A)	32 - 43	34 - 47	35 - 46
Sound pressure level at the distance of 1 m	dB (A)	24 - 35	26 - 39	27 - 38

SOUND POWER IN SILENT MODE

Sound power	dB (A)	32 - 38	34 - 38	35 - 38
Sound pressure level at the distance of 1 m	dB (A)	24 - 30	26 - 30	27 - 30

When sound is transmitted through the structure, it is necessary to equip the connection with absorbers or compensators in order to prevent the transmission of unwanted structural sound. The appliance's sound power depends on the building's actual heating needs. The lower the heating needs, the lower the noise levels, and vice versa. Sound pressure is calculated from the sound power at the hemispherical layout (Q = 2). Noise diagram of the ETERA heat pump at different inlet air temperatures and operating modes.

Description

Sound power is a characteristic of a sound source and is not related to distance; describes the total sound energy of an appropriate source that is emitted in all directions.

Sound pressure depends on the measurement site in the sound field and describes the sound pressure at that location.

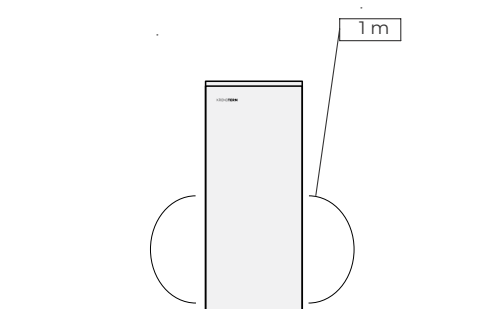

ETERA S
Sound power

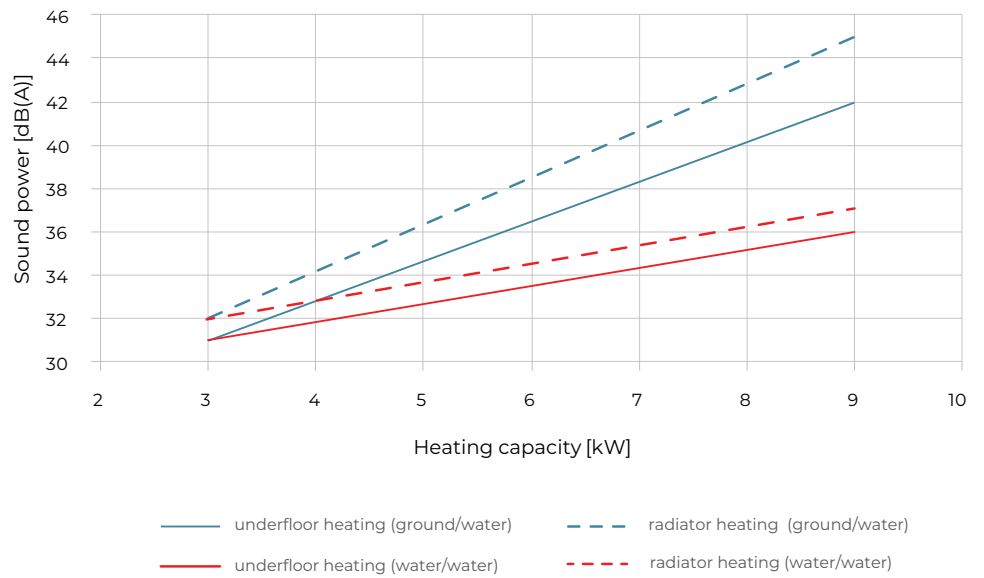

ETERA(-C) M
Sound power

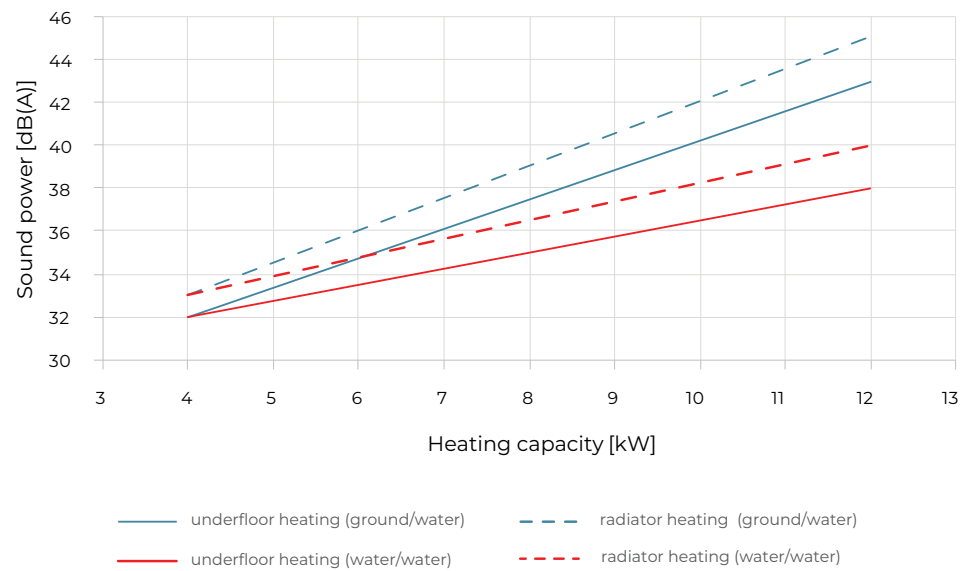

ETERA(-C) L
Sound power

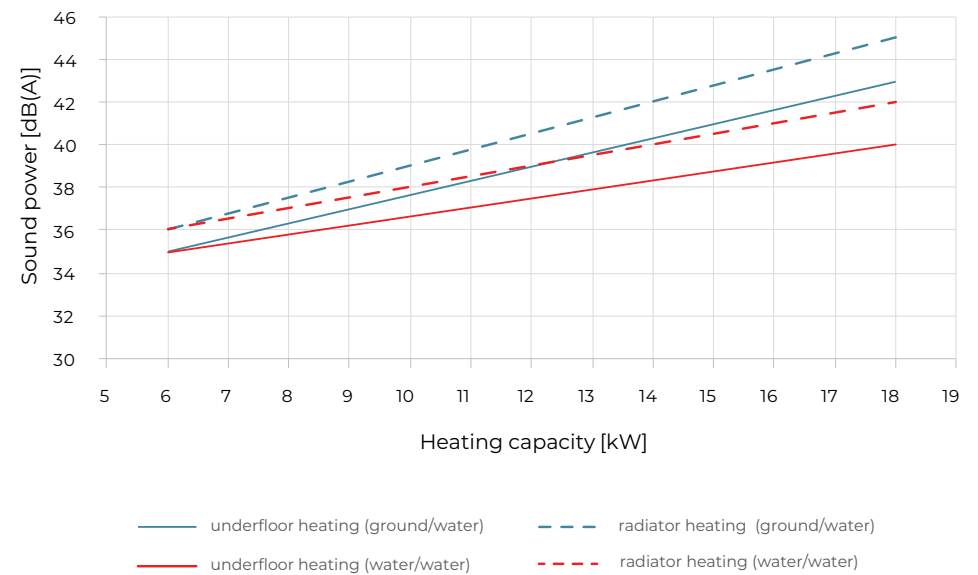

PERFORMANCE AND EFFICIENCY

APPLIANCE	Unit	ETERA S	ETERA M	ETERA(-C) M	ETERA(-C) L
		UF	UF	3F	3F

GROUND / WATER

CAPACITY ACCORDING TO STANDARD EN 14511

Rated heating capacity (B0/W35)	kW	4,5	6,1	6,1	9,1
COP (B0/W35)		4,71	4,97	4,89	5,08
Rated heating capacity (B0/W55)	kW	6,0	8,1	8,1	11,9
COP (B0/W55)		2,92	3,17	3,13	3,10
Heating capacity, max. (B0/W35)	kW	9,1	12,2	12,2	18,2
COP (B0/W35)		4,50	4,80	4,81	4,72
Heating capacity, max. (B0/W55)	kW	9,0	12,1	12,1	18,1
COP (B0/W55)		2,95	3,11	3,18	3,16
Cooling capacity	kW	2-9	4-12	4-12	6-18
EER (B15/W18)		9,23-9,13	8,73-9,03	8,73-9,03	8,57-8,90
EER (B15/W7)		6,37-5,62	6,47-5,77	6,47-5,77	6,51-5,75

SEASONAL ENERGY EFFICIENCY FOR HEATING ACCORDING TO DIRECTIVE (EU) 811/2013 – DATA SHEET

Temperature mode	°C	35 / 55	35 / 55	35 / 55	35 / 55
Seasonal energy efficiency class		A+++	A+++	A+++	A+++
Rated heating capacity $P_{designh}$, average climate zone	kW	9,1/9,0	12,1/12,1	12,2/12,1	18,2/18,1
Seasonal space heating energy efficiency η_s , average climate zone	%	210/154	220/162	220/156	230/166
Annual energy consumption average climate zone	kWh	3448/4605	4378/5895	4420/6095	6320/8602
Level of sound power LWA, indoor	dB	32/35	34/36	34/36	35/37
Rated heating capacity $P_{designh}$, cold climate zone	kW	9,1/9,0	12,1/12,1	12,2/12,1	18,2/18,1
Rated heating capacity $P_{designh}$, warm climate zone	kW	9,1/9,0	12,1/12,1	12,2/12,1	18,2/18,1
Seasonal space heating energy efficiency η_s , cold climate zone	%	218/158	226/165	225/158	241/172
Seasonal space heating energy efficiency η_s , warm climate zone	%	208/151	214/160	214/156	235/169
Annual energy consumption, cold climate zone	kWh	3979/5346	5094/6898	5167/7172	7218/9932
Annual energy consumption, warm climate zone	kWh	2254/3030	2915/3852	2935/3956	4008/5475

SEASONAL ENERGY EFFICIENCY FOR HEATING ACCORDING TO DIRECTIVE (EU) 811/2013 – DATA SHEET FOR COMPLETE SPATIAL HEATERS

Controller model		KSM	KSM	KSM	KSM
Temperature mode	°C	35 / 55	35 / 55	35 / 55	35 / 55
Class of controller for adjusting temperature		VI	VI	VI	VI
Temperature controller's contribution to seasonal efficiency	%	4,0	4,0	4,0	4,0
Seasonal space heating energy efficiency η_s for the whole set, average climate zone		A+++	A+++	A+++	A+++
Seasonal space heating energy efficiency η_s for the whole set, average climate zone	%	214/158	224/166	224/160	234/170
Seasonal space heating energy efficiency η_s for the whole set, cold climate zone	%	222/162	230/169	229/162	245/176
Seasonal space heating energy efficiency η_s for the whole set, warm climate zone	%	212/155	218/164	218/160	239/173

SEASONAL HEATING CAPACITIES ACCORDING TO STANDARD EN 14825

Rated heating capacity $P_{designh}$ 35°C/55°C – average climate zone	kW	9,1/9,0	12,1/12,1	12,2/12,1	18,2/18,1
SCOP, 35°C/55°C – average climate zone		5,45/4,04	5,71/4,24	5,70/4,10	5,95/4,35
Rated heating capacity $P_{designh}$ 35°C/55°C – warm climate zone	kW	9,1/9,0	12,1/12,1	12,2/12,1	18,2/18,1
SCOP, 35°C/55°C – warm climate zone		5,39/3,97	5,55/4,20	5,55/4,09	6,07/4,42
Rated heating capacity $P_{designh}$ 35°C/55°C – cold climate zone	kW	9,1/9,0	12,1/12,1	12,2/12,1	18,2/18,1
SCOP, 35°C/55°C – cold climate zone		5,64/4,15	5,85/4,32	5,82/4,16	6,22/4,49

APPLIANCE	Unit	ETERA S	ETERA M	ETERA(-C) M	ETERA(-C) L
		UF	UF	3F	3F

WATER / WATER

CAPACITY ACCORDING TO STANDARD EN 14511

Rated heating capacity (W10/W35)	kW	4,5	6,0	6,1	9,1
COP (W10/W35)		6,40	6,40	6,72	6,67
Rated heating capacity (W10/W55)	kW	6,1	8,1	8,1	12,1
COP (W10/W55)		3,77	3,90	3,88	3,91
Heating capacity, max. (W10/W35)	kW	9,1	12,1	12,2	18,1
COP (W10/W35)		6,43	6,70	6,63	6,50
Heating capacity, max. (W10/W55)	kW	9,1	12,1	12,1	18,2
COP (W10/W55)		3,80	4,05	3,96	3,96
Cooling capacity	kW	2-9	4-12	4-12	6-18
EER (B15/W18)		9,23-9,13	8,73-9,03	8,73-9,03	8,57-8,90
EER (B15/W7)		6,37-5,62	6,47-5,77	6,47-5,77	6,51-5,75

SEASONAL ENERGY EFFICIENCY FOR HEATING ACCORDING TO DIRECTIVE (EU) 811/2013 – DATA SHEET

Temperature mode	°C	35 / 55	35 / 55	35 / 55	35 / 55
Seasonal energy efficiency class		A+++	A+++	A+++	A+++
Rated heating capacity P _{designh} , average climate zone	kW	9,1/9,1	12,1/12,1	12,1/12,0	18,1/18,1
Seasonal space heating energy efficiency η _s , average climate zone	%	299/207	301/211	313/213	319/217
Annual energy consumption average climate zone	kWh	2449/3498	3239/4572	3118/4489	4578/6635
Level of sound power LWA, indoor	dB	32/33	32/34	32/34	35/37
Rated heating capacity P _{designh} , cold climate zone	kW	9,1/9,1	12,1/12,1	12,1/12,0	18,1/18,1
Rated heating capacity P _{designh} , warm climate zone	kW	9,1/9,1	12,1/12,1	12,1/12,0	18,1/18,1
Seasonal space heating energy efficiency η _s , cold climate zone	%	309/215	311/215	324/220	331/225
Seasonal space heating energy efficiency η _s , warm climate zone	%	299/206	301/207	317/213	320/219
Annual energy consumption, cold climate zone	kWh	2827/4026	3744/5348	3621/5190	5261/7656
Annual energy consumption, warm climate zone	kWh	1582/2278	2093/3005	1987/2902	2948/4276

SEASONAL ENERGY EFFICIENCY FOR HEATING ACCORDING TO DIRECTIVE (EU) 811/2013 – DATA SHEET FOR COMPLETE SPATIAL HEATERS

Controller model		KSM	KSM	KSM	KSM
Temperature mode	°C	35 / 55	35 / 55	35 / 55	35 / 55
Class of controller for adjusting temperature		VI	VI	VI	VI
Temperature controller's contribution to seasonal efficiency	%	4,0	4,0	4,0	4,0
Seasonal space heating energy efficiency η _s for the whole set, average climate zone		A+++	A+++	A+++	A+++
Seasonal space heating energy efficiency η _s for the whole set, average climate zone	%	303/211	305/215	317/217	323/221
Seasonal space heating energy efficiency η _s for the whole set, cold climate zone	%	313/219	315/219	328/224	335/229
Seasonal space heating energy efficiency η _s for the whole set, warm climate zone	%	303/210	305/211	321/217	324/223

SEASONAL HEATING CAPACITIES ACCORDING TO STANDARD EN 14825

Rated heating capacity P _{designh} 35°C/55°C – average climate zone	kW	9,1/9,1	12,1/12,1	12,1/12,0	18,1/18,1
SCOP, 35°C/55°C – average climate zone		7,68/5,37	7,72/5,47	8,02/5,52	8,17/5,64
Rated heating capacity P _{designh} 35°C/55°C – warm climate zone	kW	9,1/9,1	12,1/12,1	12,1/12,0	18,1/18,1
SCOP, 35°C/55°C – warm climate zone		7,68/5,34	7,72/5,38	8,13/5,52	8,20/5,69
Rated heating capacity P _{designh} 35°C/55°C – cold climate zone	kW	9,1/9,1	12,1/12,1	12,1/12,0	18,1/18,1
SCOP, 35°C/55°C – cold climate zone		7,93/5,57	7,97/5,58	8,31/5,70	8,48/5,83

OPERATING RANGE

HEATING

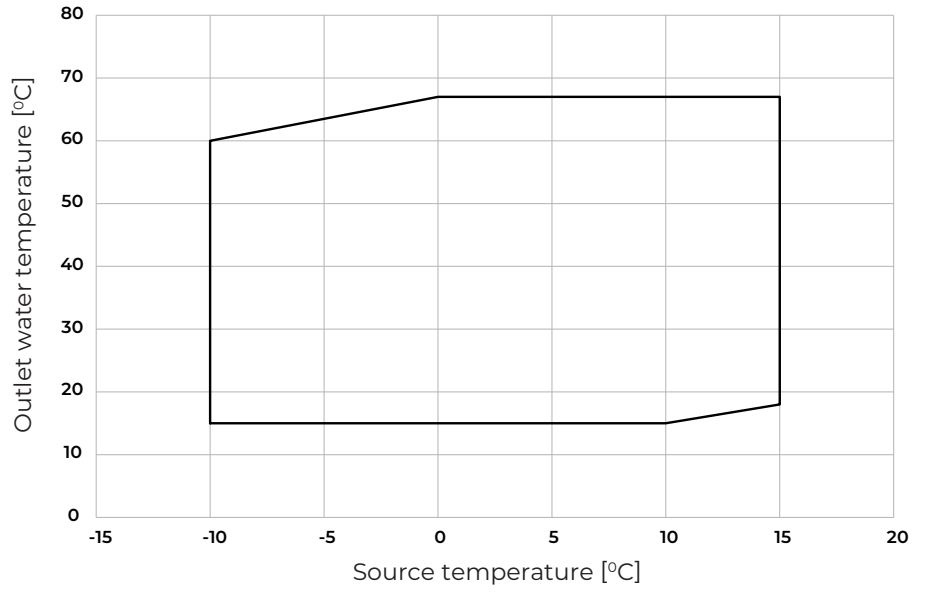

COOLING

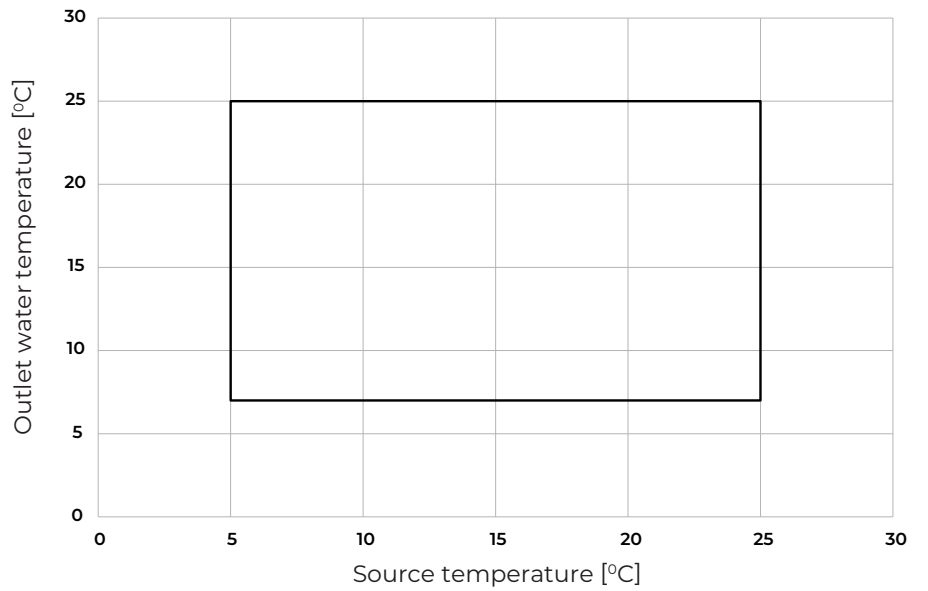

DOMESTIC HOT WATER (DHW)

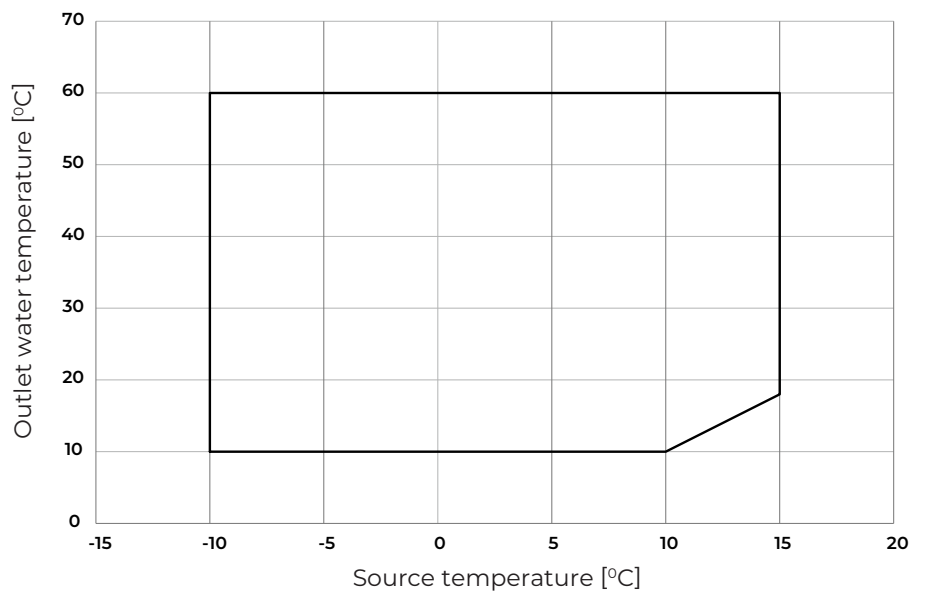

CAPACITY CURVES

ETERA S Heating capacity

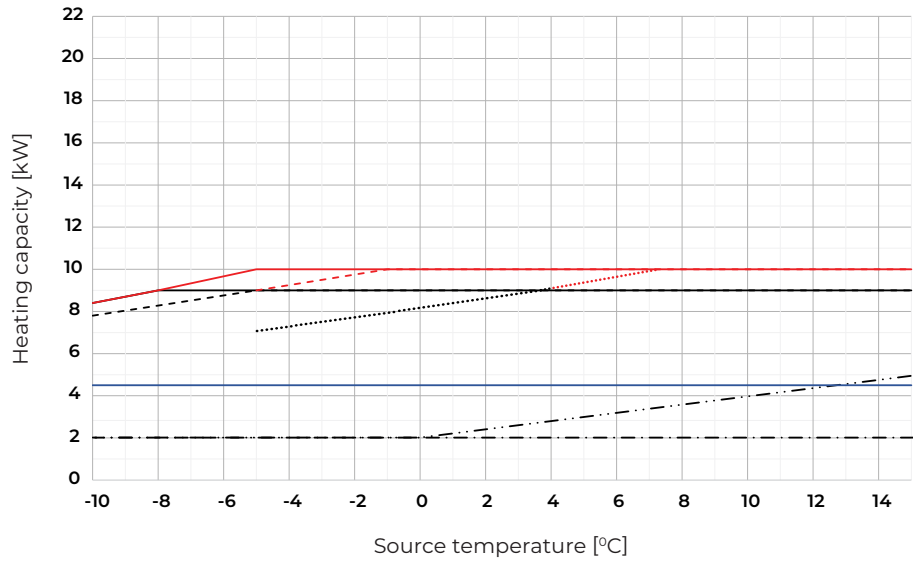

ETERA(-C) M Heating capacity

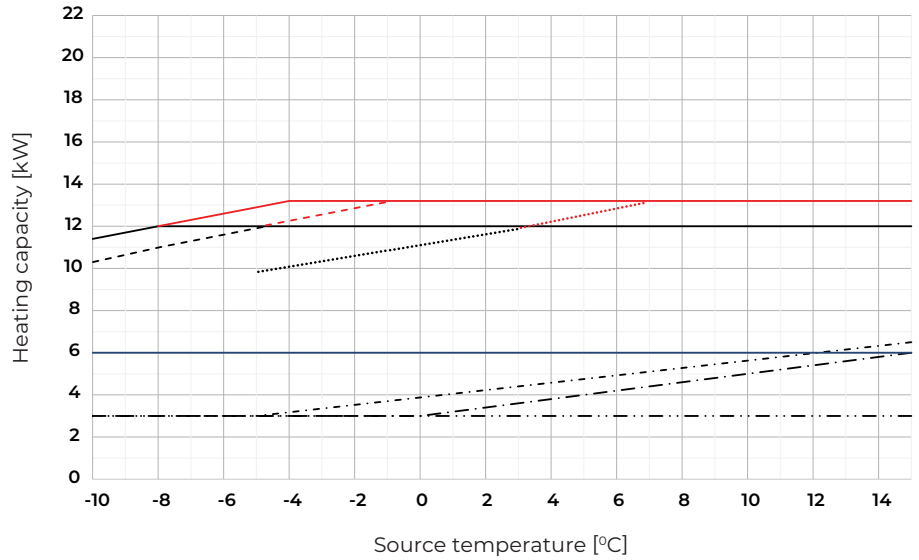

ETERA(-C) L Heating capacity

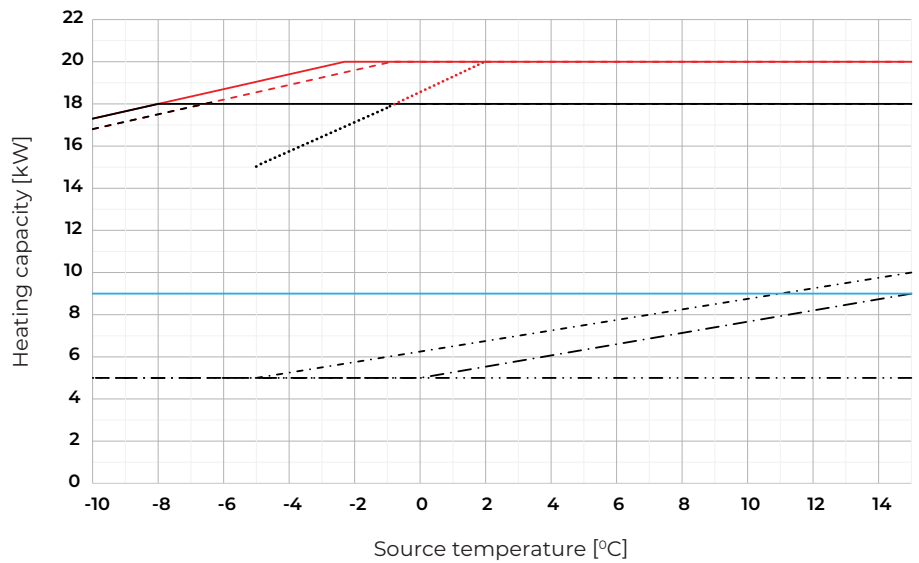

- 35°C - max OPTIMAL
- - - 55°C - max OPTIMAL
- · - 35°C - min
- · · 55°C - min
- max SILENT
- 35°C - max BOOST
- - - 55°C - max BOOST

The maximum heat capacity of the heat pump depends on selected operation mode. **BOOST**: in this mode the heat pump has a higher maximum capacity, high levels of noise, and low efficiency. **OPTIMAL**: in this mode the heat pump has the highest level of efficiency and the best ratio between heating capacity and noise levels. **SILENT**: in this mode the heat pump has low noise level, a lower maximum heating capacity, and low efficiency.

CAPACITY CURVES

ETERA S
Cooling capacity

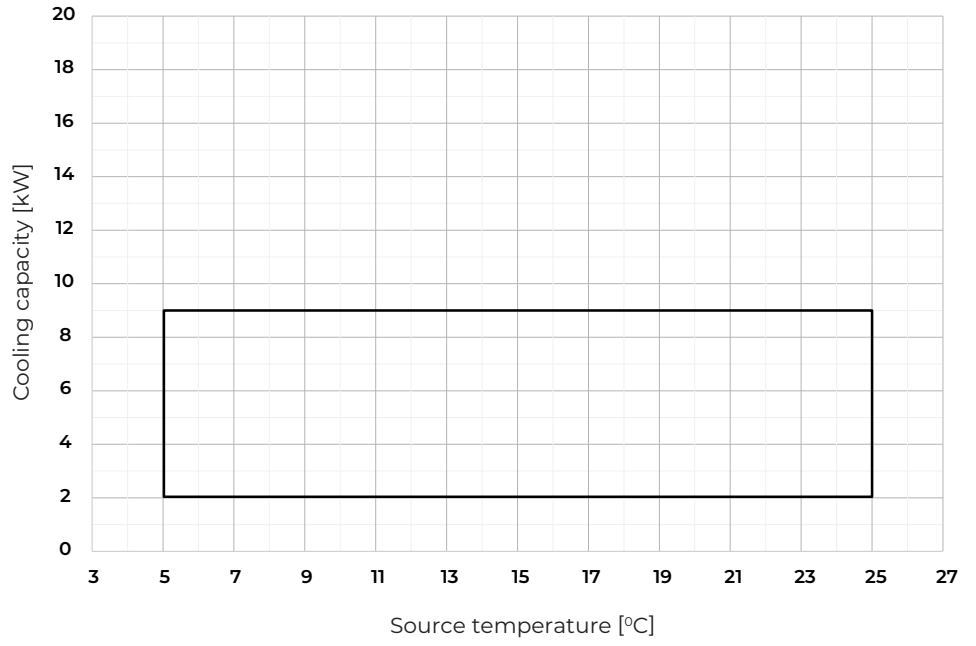

ETERA(-C)M
Cooling capacity

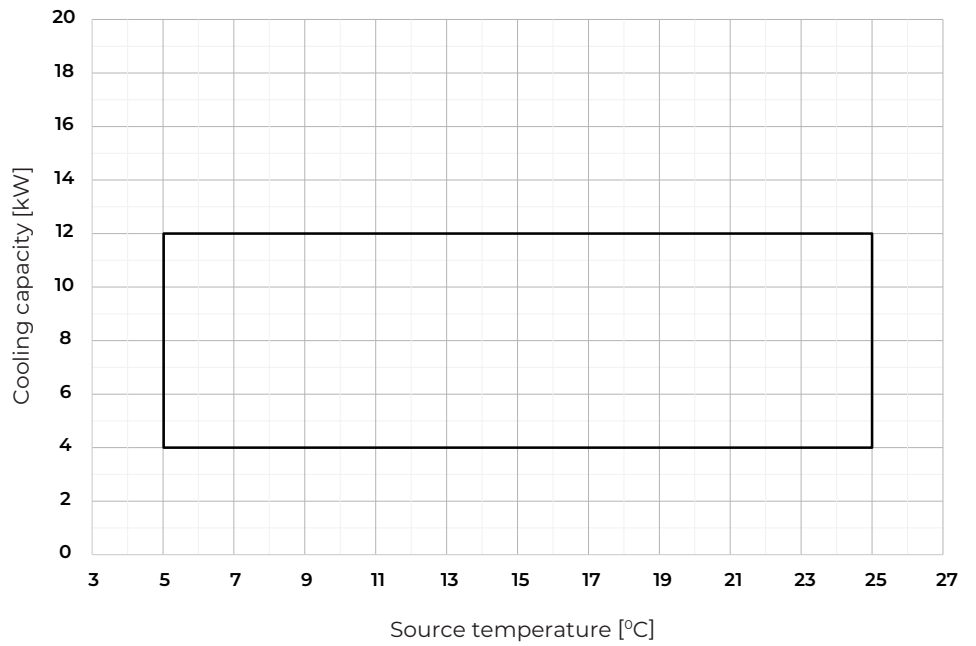

ETERA(-C)L
Cooling capacity

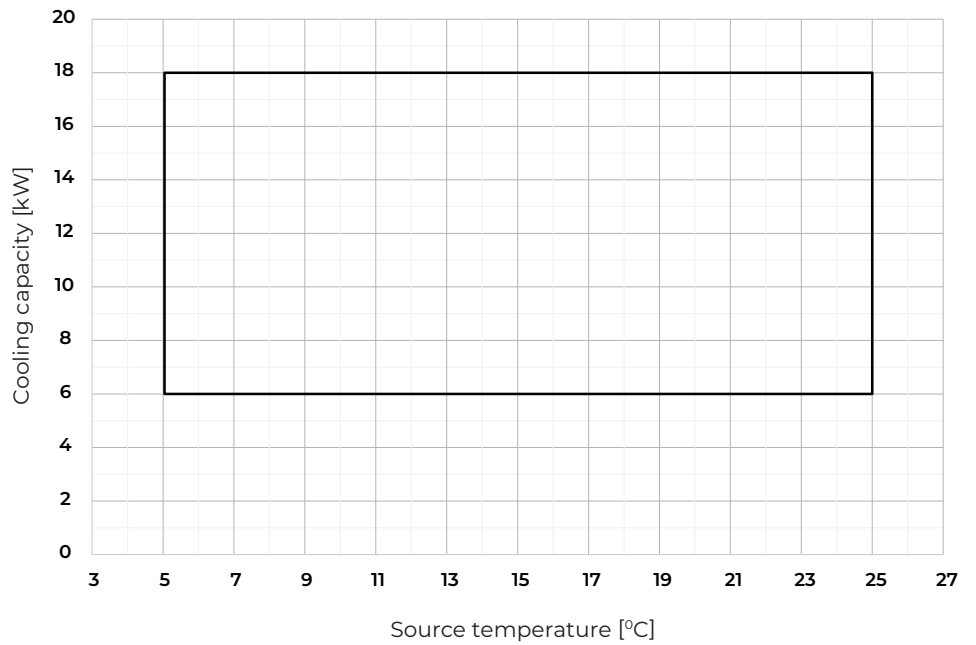

BASIC INSTALLATION DIAGRAM

ETERA system with horizontal geothermal collector

ETERA + HYDRO B

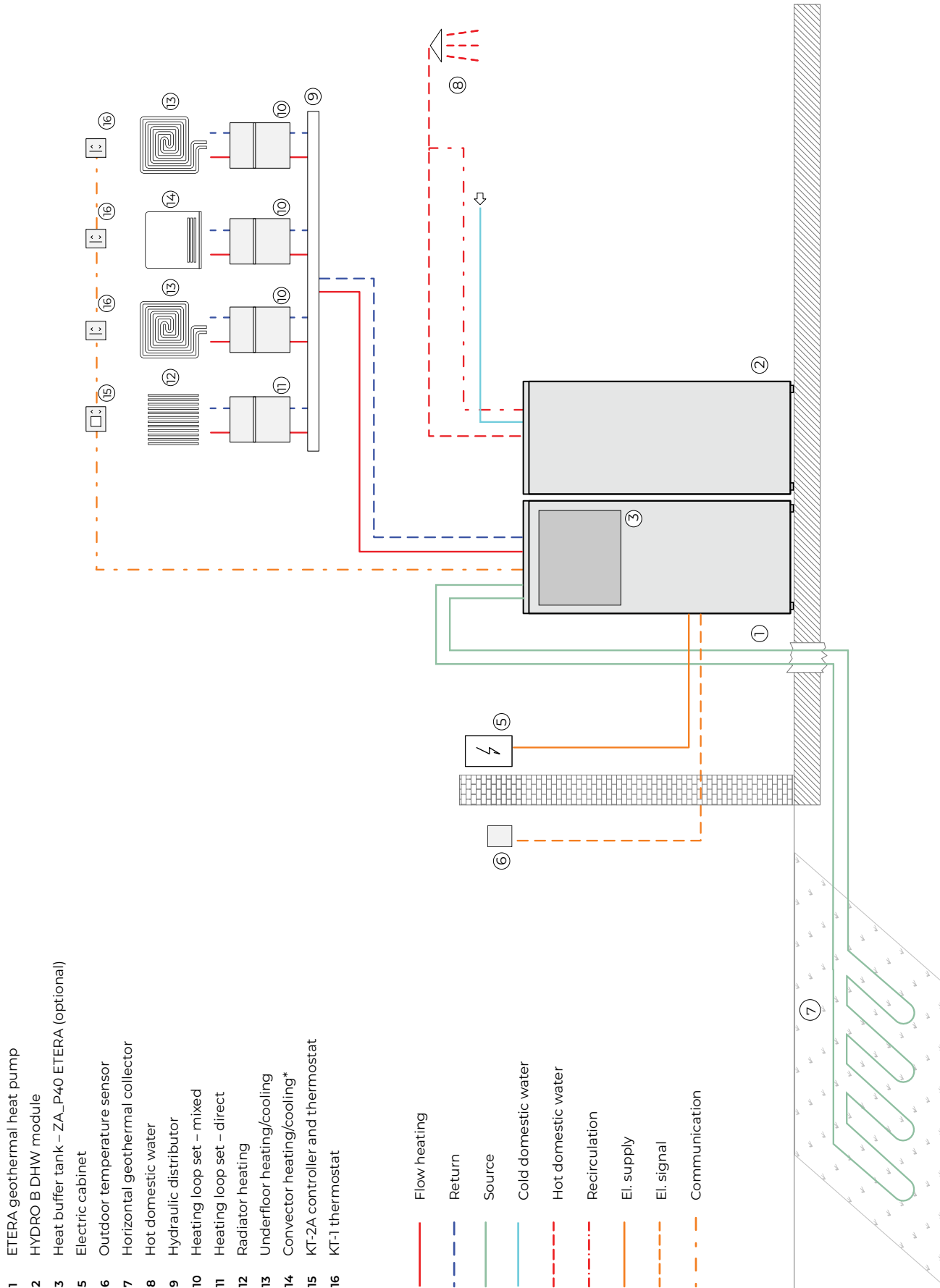

An informative set of items from the KRONOTERM sales program is shown. For proper system planning, use the KRONOTERM SOLUTIONS app on the KRONOTERM partner portal.
*When using convectors for cooling, please refer to "Preparing for installation" instructions for the ETERA system.

BASIC INSTALLATION DIAGRAM

ETERA system with vertical geothermal collector and MODUL_PASIVA ETERA for passive cooling

ETERA + HYDRO B + MODUL_PASIVA ETERA

- 1 ETERA geothermal heat pump
- 2 HYDRO B DHW module
- 3 Heat buffer tank – ZA_P40 ETERA (optional)
- 4 MODUL_PASIVA ETERA (optional)
- 5 Electric cabinet
- 6 Outdoor temperature sensor
- 7 Vertical geothermal collector
- 8 Hot domestic water
- 9 Hydraulic distributor
- 10 Heating loop set – mixed
- 11 Heating loop set – direct
- 12 Radiator heating
- 13 Underfloor heating/cooling
- 14 Convector heating/cooling*
- 15 KT-2A controller and thermostat
- 16 KT-1 thermostat

- Flow heating
- - - Return
- Source
- Cold domestic water
- - - Hot domestic water
- · - · - Recirculation
- El. supply
- - - El. signal
- · - · - Communication

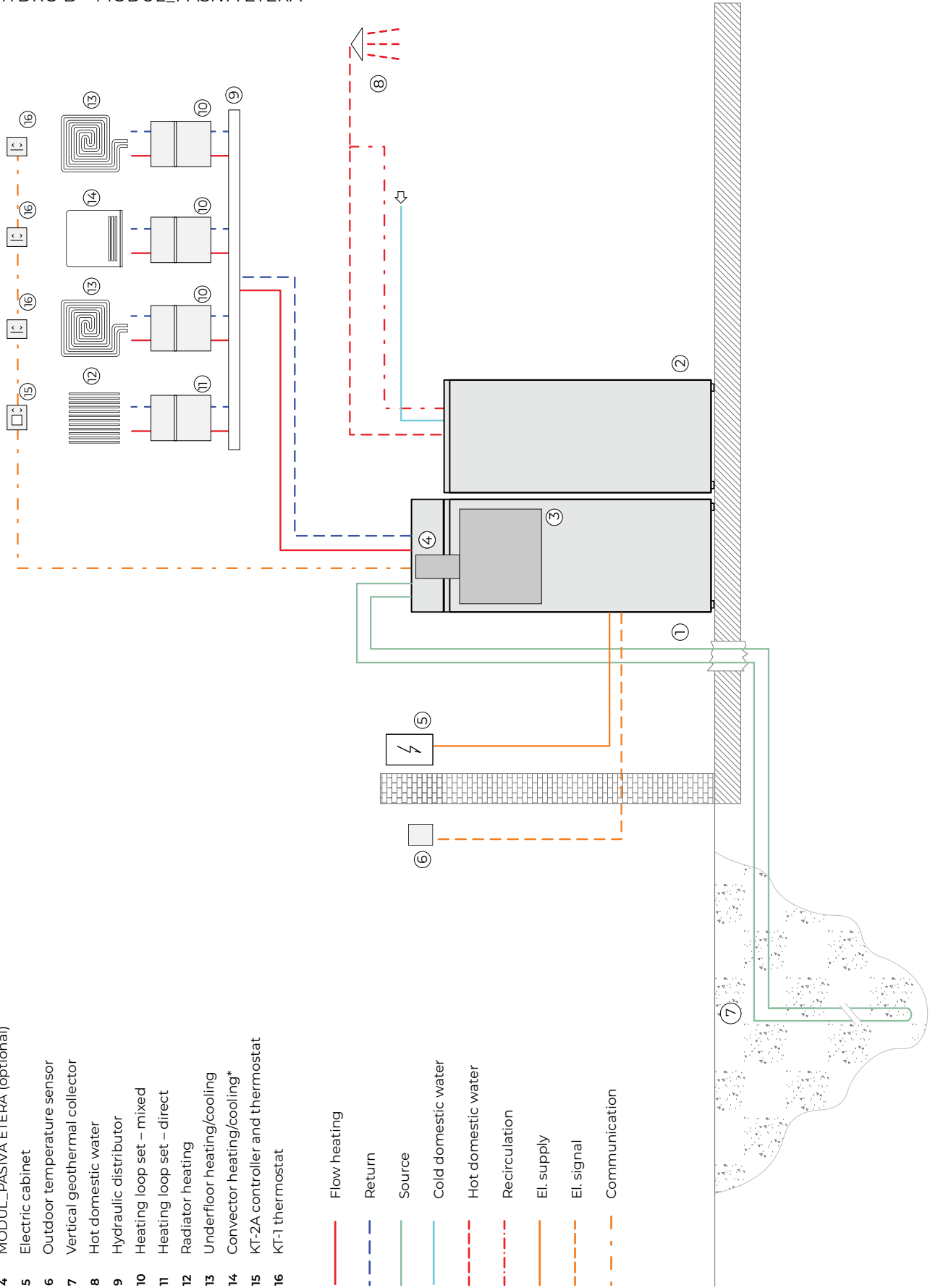

An informative set of items from the KRONOTERM sales program is shown. For proper system planning, use the KRONOTERM SOLUTIONS app on the KRONOTERM partner portal.
*When using convectors for cooling, please refer to "Preparing for installation" instructions for the ETERA system.

BASIC INSTALLATION DIAGRAM

ETERA system with groundwater heat source and MODUL_PIL-PASIVA ETERA for passive cooling

ETERA + HYDRO B + MODUL_PIL-PASIVA ETERA

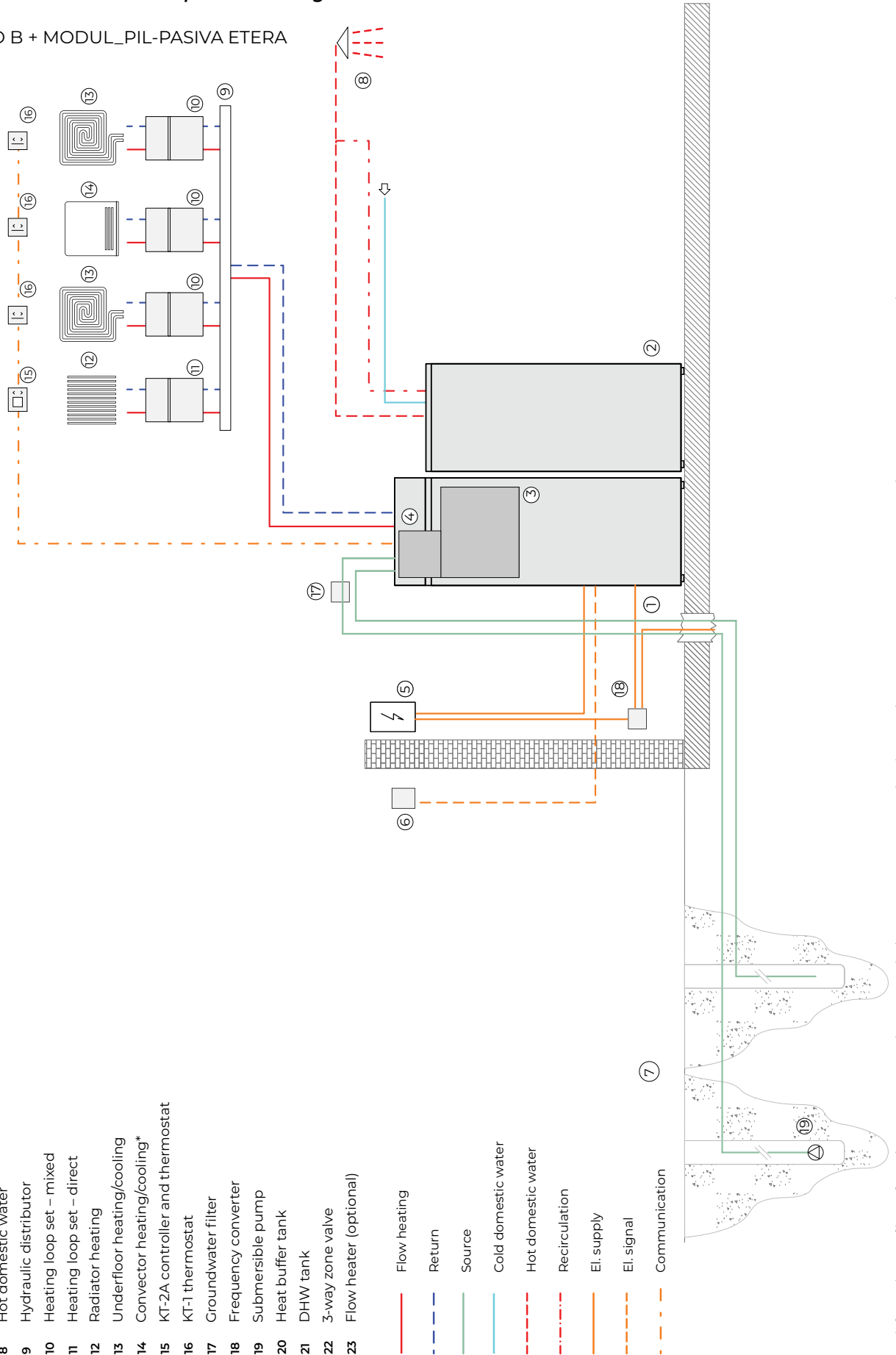

- 1 ETERA geothermal heat pump
- 2 HYDRO B DHW module
- 3 Heat buffer tank – ZA_P40 ETERA (optional)
- 4 MODUL_PIL-PASIVA ETERA (optional)
- 5 Electric cabinet
- 6 Outdoor temperature sensor
- 7 Heat source - groundwater
- 8 Hot domestic water
- 9 Hydraulic distributor
- 10 Heating loop set – mixed
- 11 Heating loop set – direct
- 12 Radiator heating
- 13 Underfloor heating/cooling
- 14 Convector heating/cooling*
- 15 KT-2A controller and thermostat
- 16 KT-1 thermostat
- 17 Groundwater filter
- 18 Frequency converter
- 19 Submersible pump
- 20 Heat buffer tank
- 21 DHW tank
- 22 3-way zone valve
- 23 Flow heater (optional)

- Flow heating
- - - Return
- Source
- Cold domestic water
- - - Hot domestic water
- . - . Recirculation
- El. supply
- - - El. signal
- . - . Communication

An informative set of items from the KRONOTERM sales program is shown. For proper system planning, use the KRONOTERM SOLUTIONS app on the KRONOTERM partner portal.
*When using convectors for cooling, please refer to "Preparing for installation" instructions for the ETERA system.

BASIC INSTALLATION DIAGRAM

ETERA system with groundwater heat source and MODUL_PIL-PASIVA ETERA for passive cooling

ETERA-C

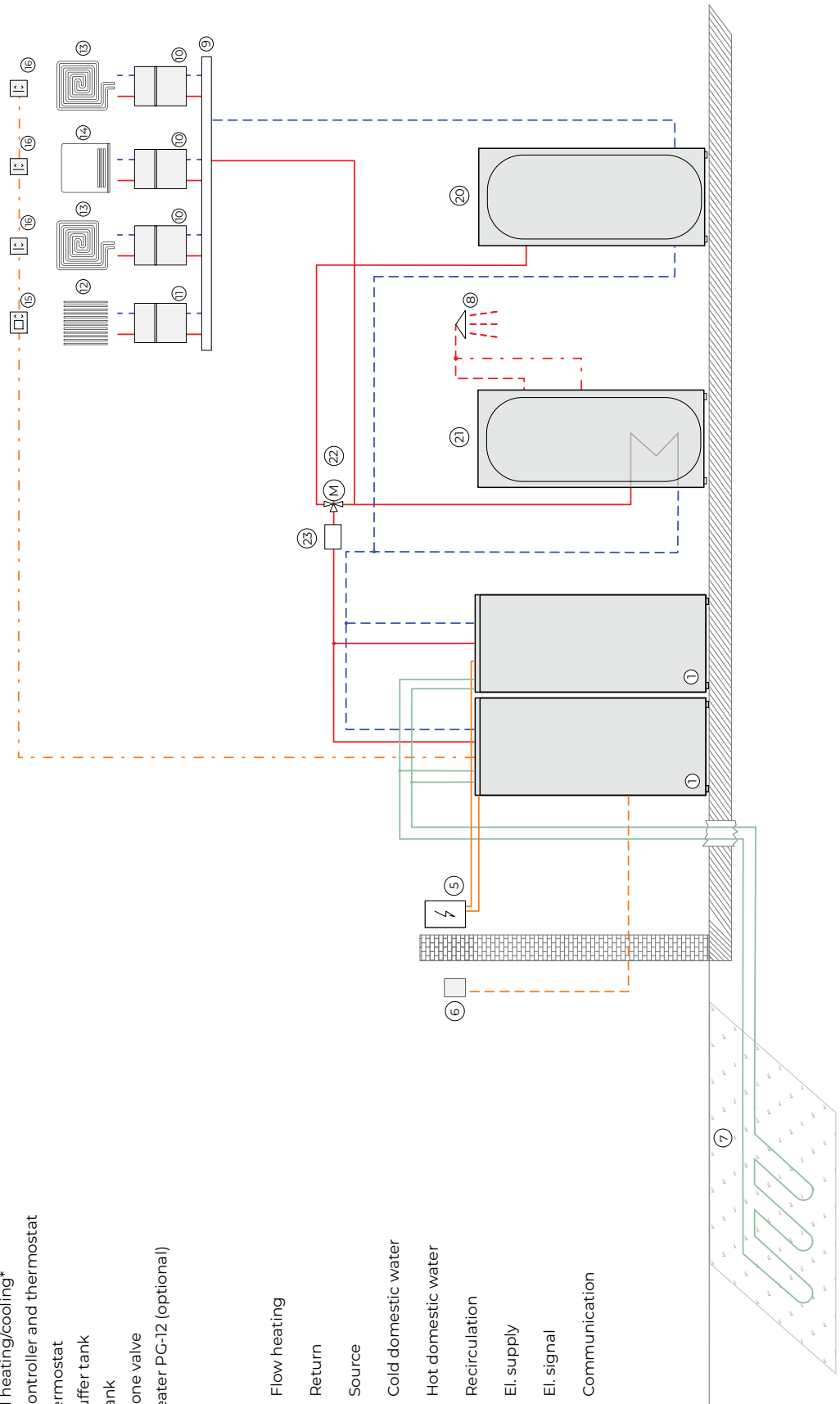

- 1 ETERA geothermal heat pump
- 5 Electric cabinet
- 6 Outdoor temperature sensor
- 7 Horizontal geothermal collector
- 8 Hot domestic water
- 9 Hydraulic distributor
- 10 Heating loop set – mixed
- 11 Heating loop set – direct
- 12 Radiator heating
- 13 Underfloor heating/cooling
- 14 Fan coil heating/cooling*
- 15 KT-2A controller and thermostat
- 16 KT-1 thermostat
- 20 Heat buffer tank
- 21 DHW tank
- 22 3-way zone valve
- 23 Flow heater PC-12 (optional)

- Flow heating
- - - Return
- Source
- Cold domestic water
- - - Hot domestic water
- · - · - Recirculation
- El. supply
- - - El. signal
- · - · - Communication

An informative set of items from the KRONOTERM sales program is shown. For proper system planning, use the KRONOTERM SOLUTIONS app on the KRONOTERM partner portal.
*When using fan coils for cooling, please refer to "Preparing for installation" instructions for the ETERA system.

BASIC INSTALLATION DIAGRAM

ETERA cascade system with groundwater heat source

ETERA-C + SET_PIL ETERA-C

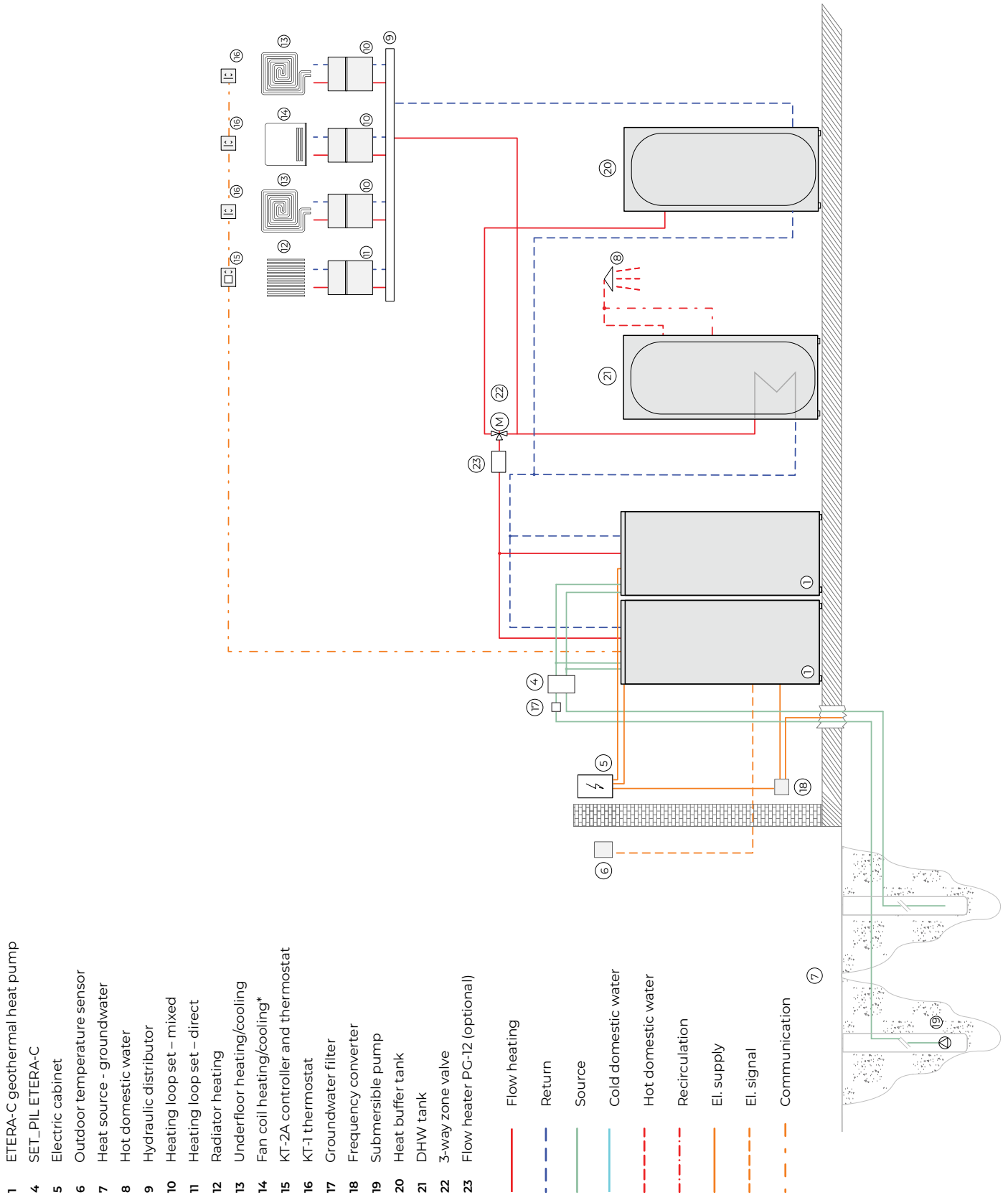

An informative set of items from the KRONOTERM sales program is shown. For proper system planning, use the KRONOTERM SOLUTIONS app on the KRONOTERM partner portal.
*When using fan coils for cooling, please refer to "Preparing for installation" instructions for the ETERA system.

KRONOTERM d.o.o.

Trnava 5e, 3303 Gomilsko, SLO

T +386 3 703 16 20

www.kronoterm.com

info@kronoterm.com