

PROTECTOR P1-P5

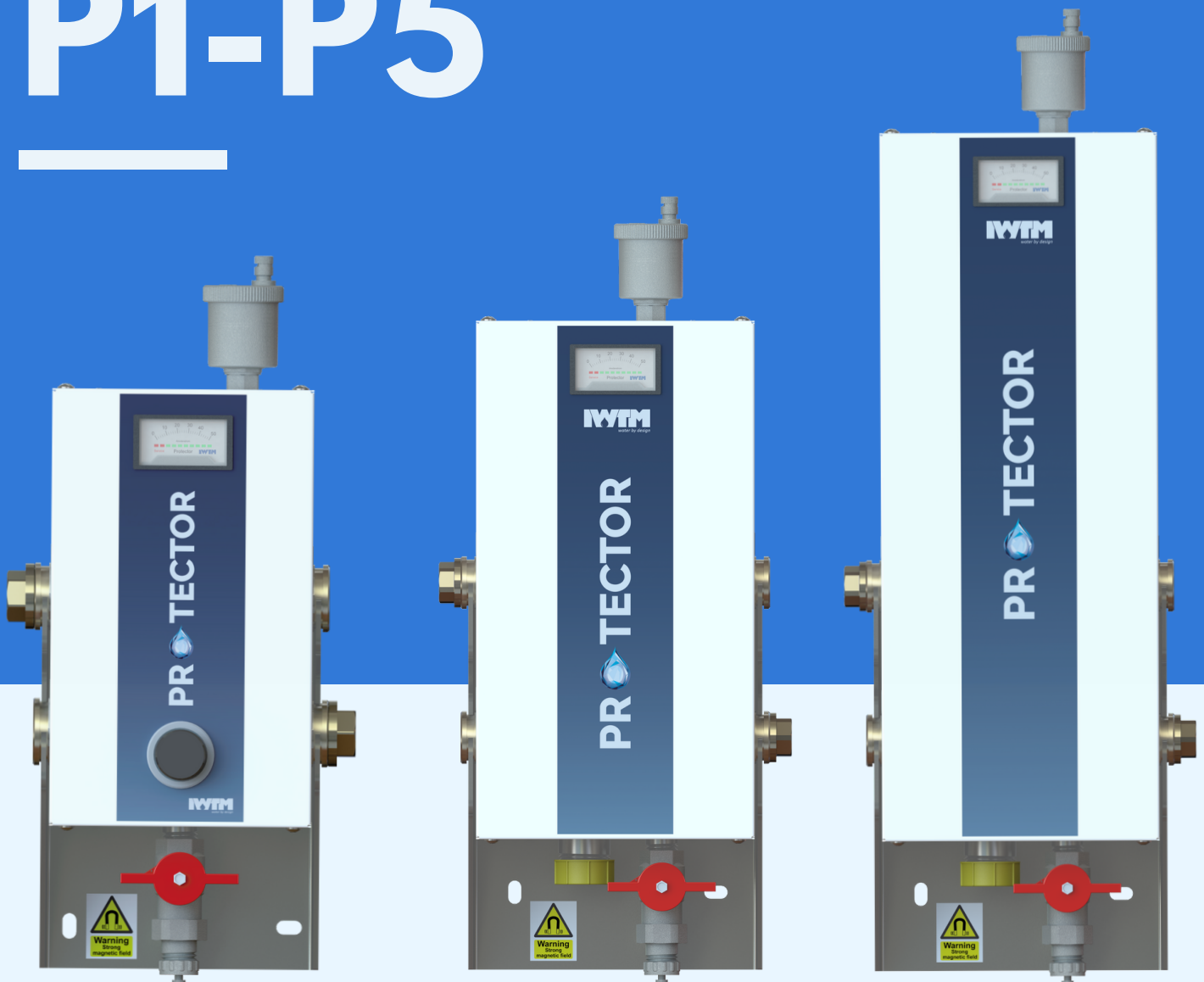

WWW.IWTM-UK.COM

T: +44 208 255 2903

E: INFO@IWTM-UK.COM

TABLE OF CONTENTS

03 PROTECTOR P1-P5 DESCRIPTION

05 PROTECTOR P1-P5 FUNCTIONS

06 FILTERING ELEMENTS

08 CONNECTION OPTIONS

09 DETAILED INTERNAL AND
EXTERNAL VIEW

11 DIMENSIONS

14 TECHNICAL DATA

15 VALVE KIT

UK PATENT PENDING:



PROTECTOR P1- P5 DESCRIPTION

ALL-IN-ONE FILTRATION AND WATER TREATMENT UNIT.

WHAT IS IT AND HOW DOES IT WORK?

Protector P1-P5 are the smallest models from our IWTM Protector™ range. There are three models, P1, P2 and P5. Each has two distinct separate treatment chambers, designed to remove the system impurities and to engineer the water to keep it in a non-corrosive state.

It provides a “hybrid/multipurpose function” that eliminates the use of chemicals, de-aerators, and magnetic separators.

The units provide faster clean-up of old systems and quicker compliance with pre commissioning targets on new systems due to the higher flow rates through the reaction tank (cathode) and the inbuilt strainer basket that enables finer filtration.

The system water enters the lower chamber where a dry powerful magnet holds in place any magnetite particles, these will be held in the lower chamber until the Protector is drained or blown down to release and remove them.

After the lower chamber, the water then passes into the upper chamber and is forced through a high grade 40-micron stainless steel filter before going back into the system having been cleaned and treated. The micron filter will capture any non-magnetic particles and prevent them from re-entering the system. These particles will be held in the micron filter and will drop to the lower chamber when the Protector is being blown down to clear the collected debris.

Within the upper chamber, due to the process of cyclone filtration, air will be pushed upwards and released through the automatic air vent and discharged to atmosphere.

Within the upper chamber and in the middle of the micron filter is where the electrochemistry takes place. The Protector uses pure magnesium bare anodes and with the micron filter basket and tank being connected these two components increase the surface area of the cathode. This increased surface area of cathode produces a higher rate of electrochemical reaction which results in increased cleaning power and superior performance than other devices.

Protector P1-P5 is completely insulated and clad to prevent heat loss and condensation. P1 can be installed both side stream and full flow.

P2-5 is installed as a side stream device only.

The bare sacrificial anode consumes the dissolved oxygen by the process of corrosion, the fast corrosion rate of the bare anode quickly releases magnesium hydroxide into the water, and this provides an alkaline pH between 8.2 and 10. The consumption of the dissolved oxygen removes the threat of corrosion from the system water. Compliance with VDI 2035 is still obtained as the anodes sit inside the basket to capture the magnesium residue when the anodes expire.

FIXING SYSTEMS + MAINTENANCE

EASILY INSTALL THE PROTECTOR ON THE WALL

Protector P1-P5 has a compact wall fixing system; therefore the unit can be fixed on to the wall to save space in situations where space is important and limited. The system is included as a standard feature in the Protector P1-P5.

The wall fixing bracket is stainless steel, very robust and resistant.

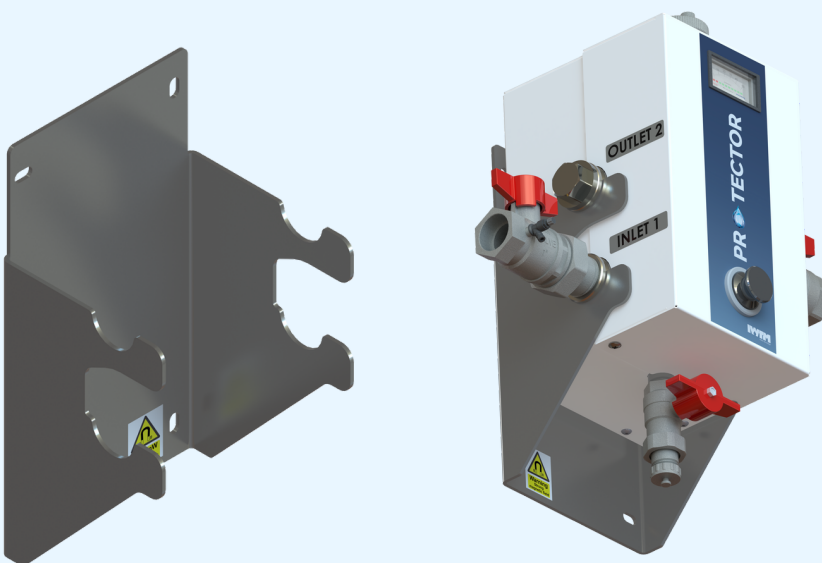

MAINTENANCE

When the progressive build-up of suspended solids retained by the stainless-steel screen causes a reduction in flow, the screen must be cleaned.

To perform the cleaning operations, there are two options either a normal backflush of the filter, or by complete removal and washing of the filter.

PROTECTOR P1-P5 FUNCTIONS

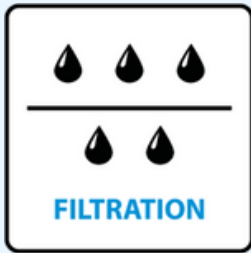

PARTICLE
FILTRATION

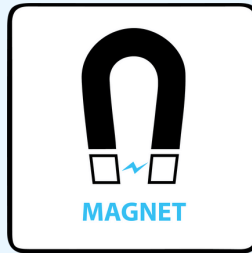

MAGNETIC
PROTECTION



REDUCES
DISSOLVED OXYGEN

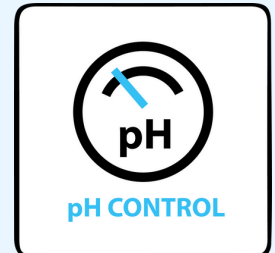

CORROSION
PREVENTION

Prevents Corrosion

Protector's water treatment features prevent corrosion in the system. This is achieved thanks to magnesium anodes that lower oxygen, regulate pH, and reduce electrical conductivity.

All In One

Protector is an "all in one solution". It combines several different technologies in one single extremely functional and reliable device.

Traps Ferrous Particles

Protector is equipped with Neodymium Magnets that trap ferrous particles, drastically increasing the time before manual intervention is needed.

Removes Contamination

Protector cleans and restores recirculating systems by removing suspended particles.

+ PROVIDES	- REPLACES
Sludge and particle removal	Bag filters
Magnetite Removal	Magnet filters
pH adjustment	Chemicals
Oxygen consumption	Air separators
Anodic water treatment	Dosing pots + automatic dosing systems

PROTECTOR P1-P5 FUNCTIONS

SIDE STREAM USING SYSTEM PUMP

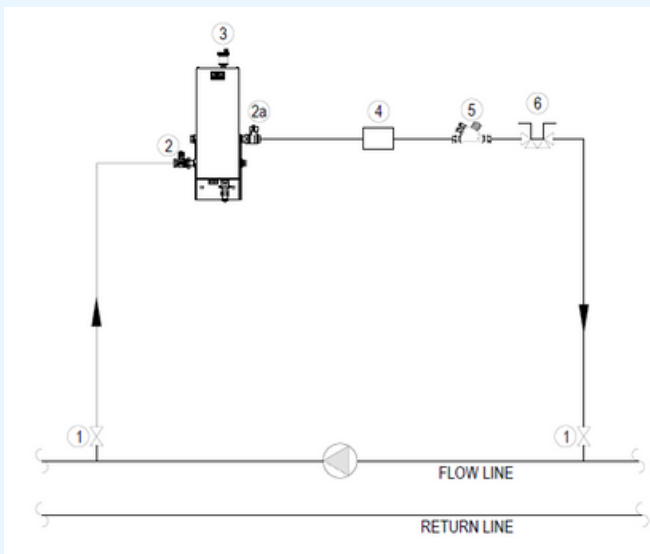

Protector P1-P5 is completely insulated and cladded to prevent heat loss and condensation. P1 can be installed both side stream and full flow.

P2-5 is installed as a side stream device only.

SIDE STREAM USING INDIVIDUAL PUMP

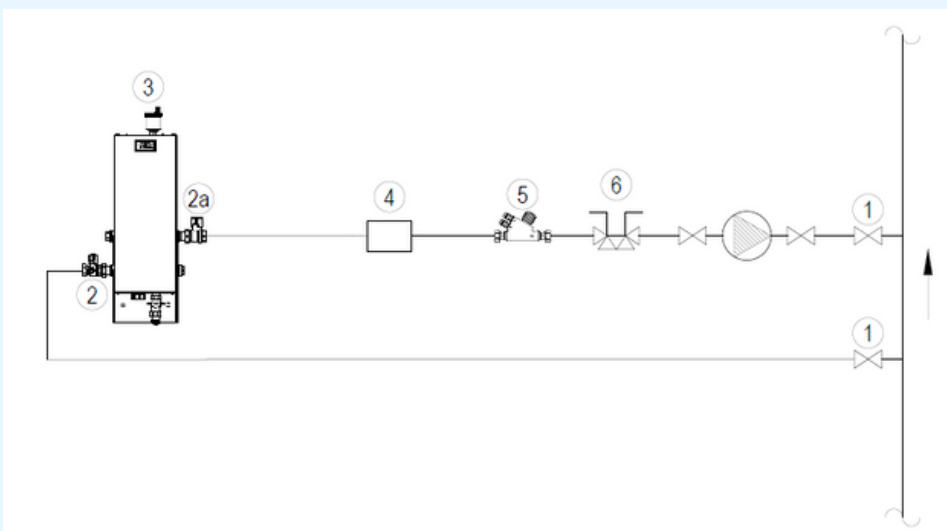

Protector P1-P5 keeps your system clean with the filtering element, removing suspended particles from the recirculating system.

PROTECTOR P1-P5 FUNCTIONS & FILTER ELEMENTS

P1 FULL FLOW

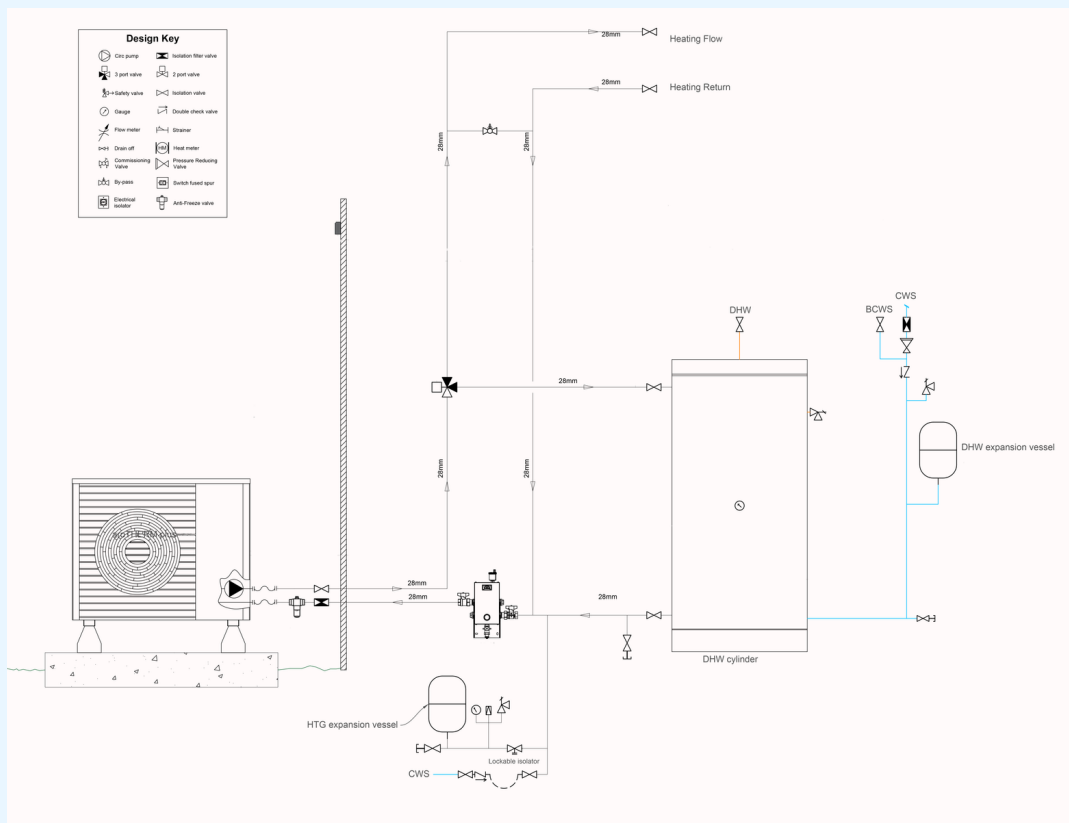

The P1 is ideally suited to ASHP applications as our technology keeps the system clean. ASHP's require clean and air free water, if the water quality is full of air or dirty the ASHP can lock out and result in nuisance shut down. Also, as ASHP's operate on a lower temperature any % reduction in output due to scaled or blocked pipes can result in the design criteria not being achieved and inconvenience for the homeowner/building operator.

PARTICLE FILTRATION

Protector P1-P5 comes as standard with a robust stainless steel filter which is 40 micron. Stainless steel AISI 316.

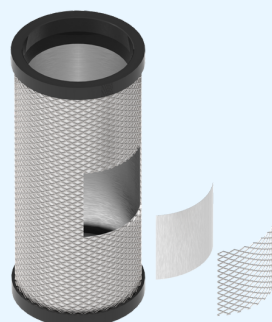

2-Layer S.S Filter

The filter has a large surface which gives a long operating time before cleaning and thus less flushing and refilling.

P1 - P5 CONNECTION OPTIONS

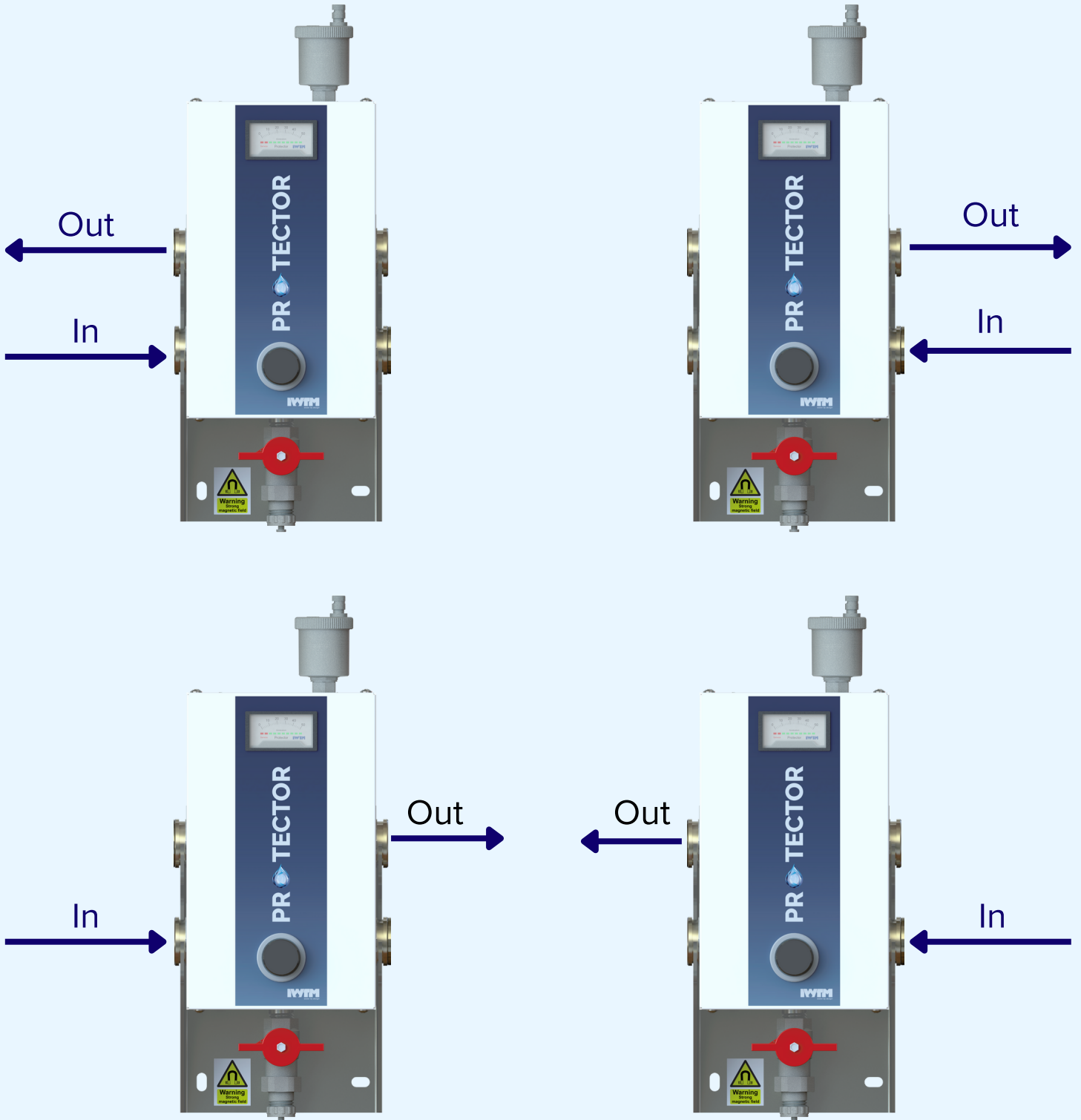

DETAILED EXTERNAL & INTERNAL VIEW P2 & P5

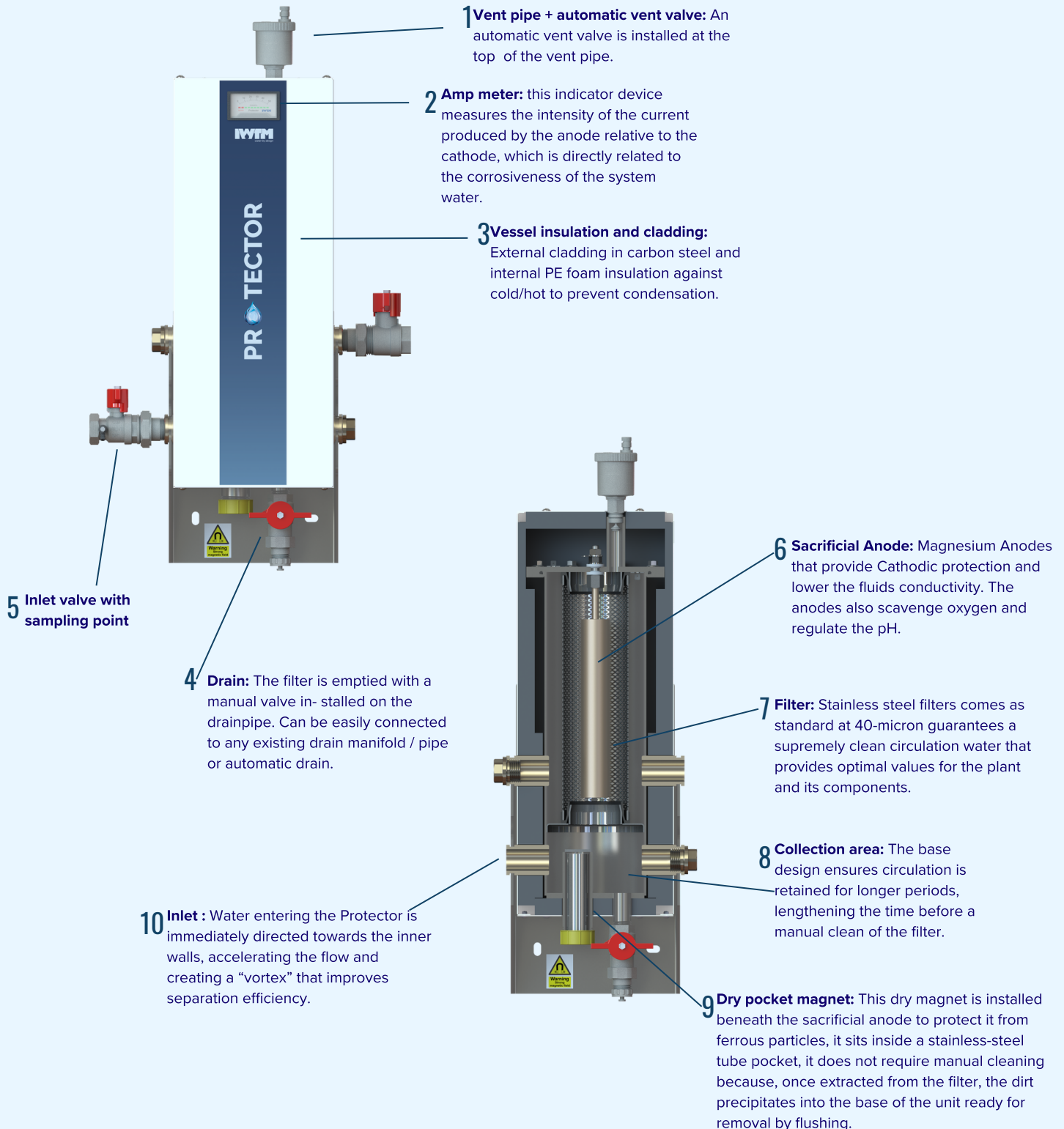

DETAILED EXTERNAL & INTERNAL VIEW P1

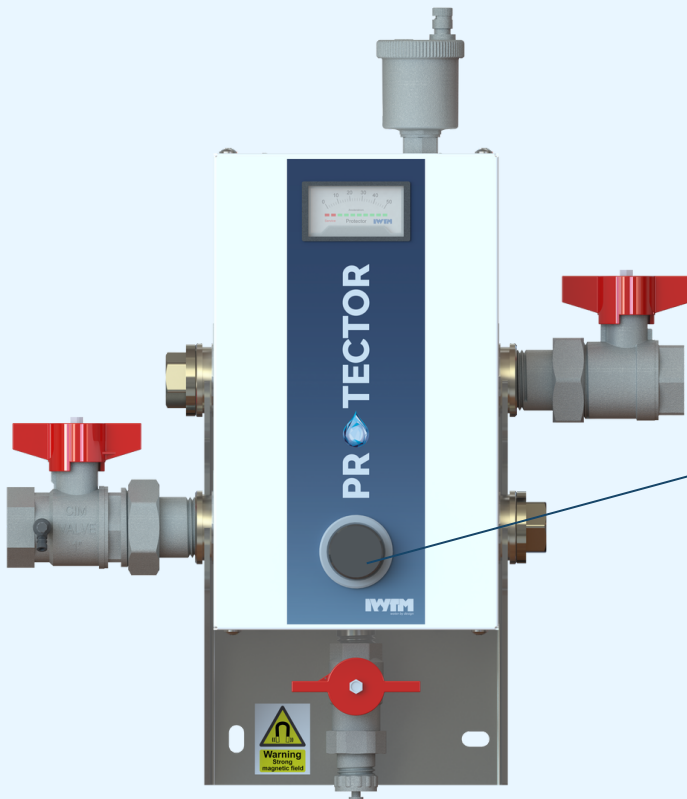

Surface mounted dry magnet: This dry magnet is installed beneath the sacrificial anode to protect it from ferrous particles, it does not require manual cleaning because, once extracted from the filter, the dirt precipitates into the base of the unit ready for removal by flushing.

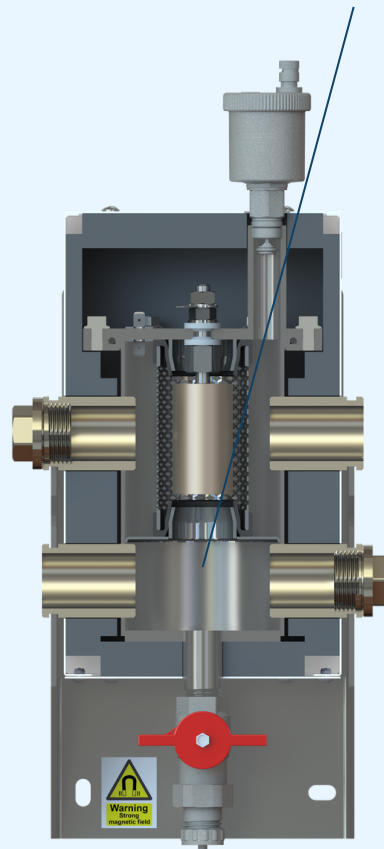

DIMENSIONS

PROTECTOR P1

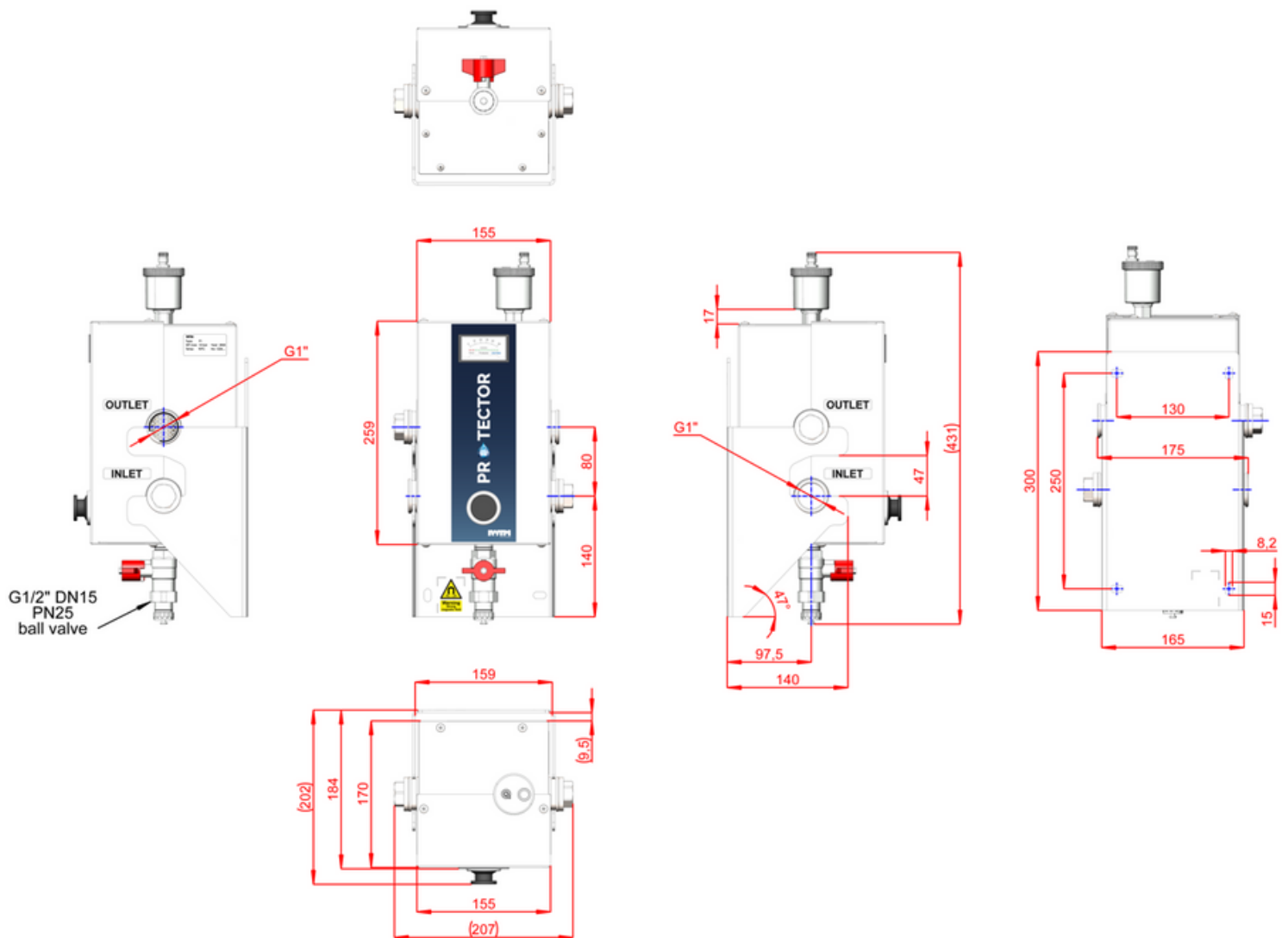

DIMENSIONS

PROTECTOR P2

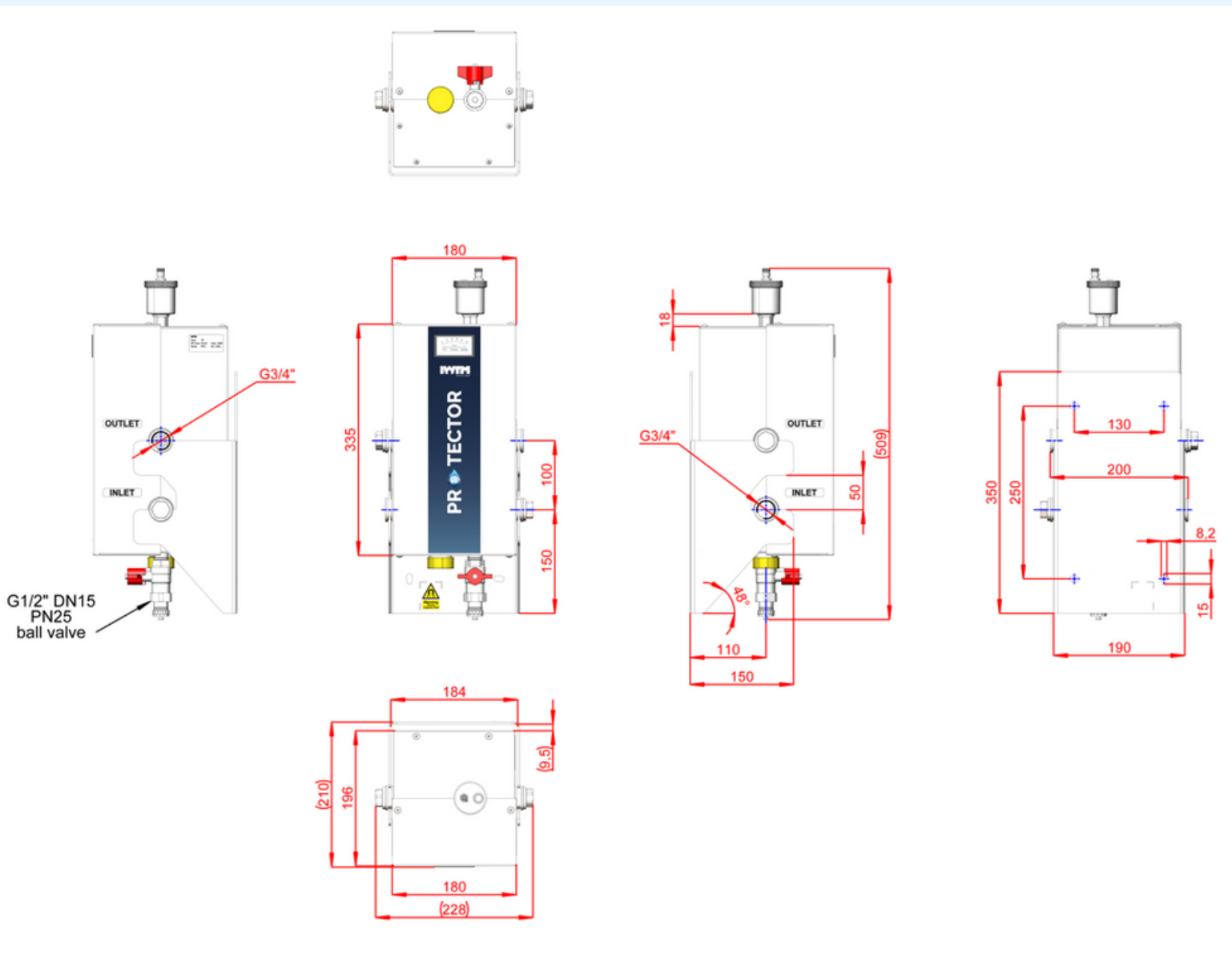

DIMENSIONS

PROTECTOR P5

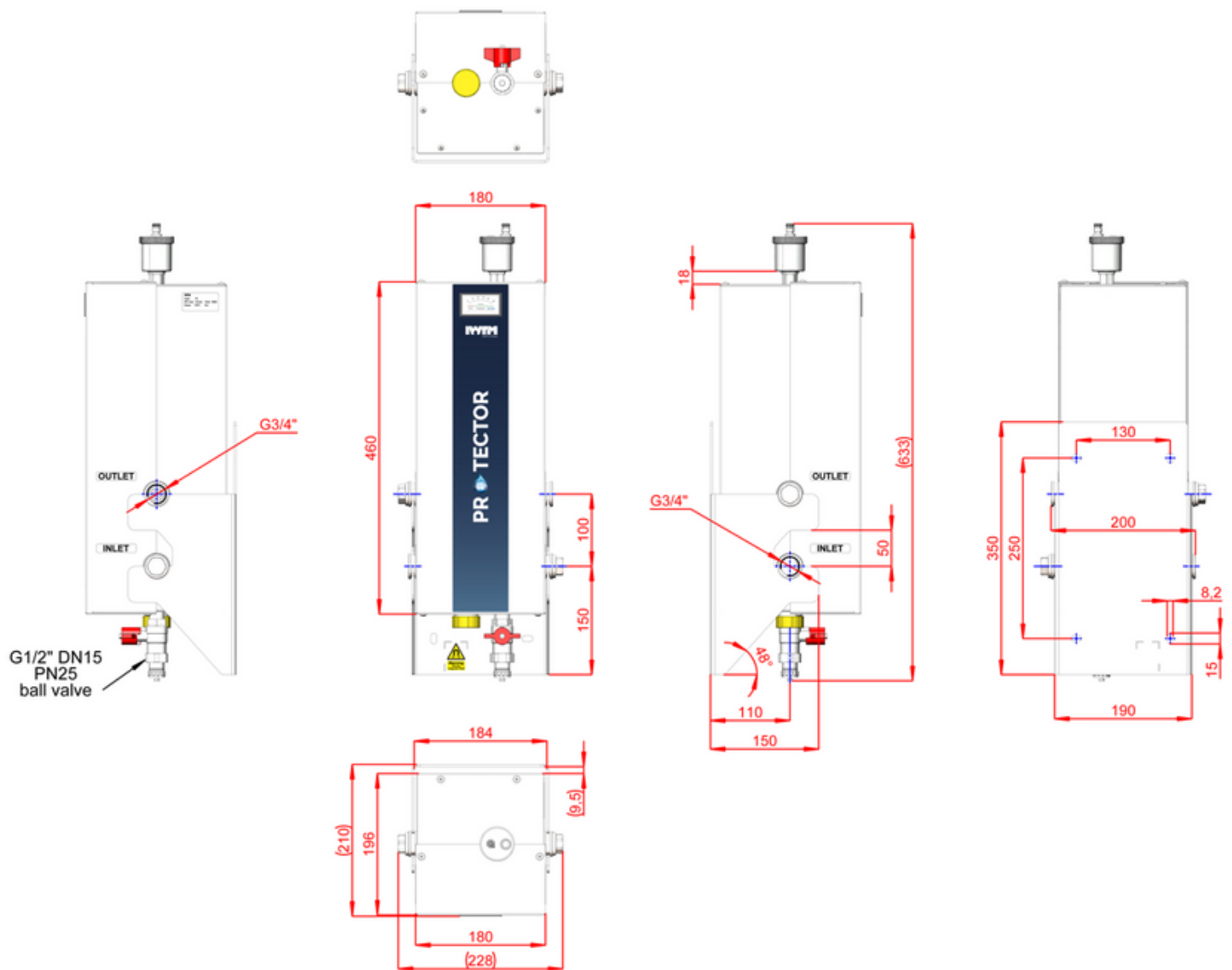

TECHNICAL DATA

	LTHW (litres)	Kw	Cooling (litres)	kw	Full flow	Side Stream	Connections	Volume	Max temp	Max Pressure	Design code
P1	1,000	91	700	47	28 l/min	4 l/min	1"	0.9 L	95	10	PED 2014/68 /EU
P2	2,000	182	1,400	94	NA	5 l/min	3/4"	2 L	95	10	PED 2014/68 /EU
P5	5,000	455	3,500	233	NA	8 l/min	3/4"	3 L	95	10	PED 2014/68 /EU

MATERIALS

Component	Component Material
Filter Housing	Stainless Steel AISI 304
Filter Screen	Stainless Steel AISI 316L
O ring EPDM	EPDM
Insulation / cladding	PE Foam / Carbon Steel
Anodes	Magnesium
Magnets	Neodymium
Surface Finishing	Powder Coated

VALVE KIT

UK Installation Kit (also available for outside UK)
P2-P5 all times, P1 when used in side stream

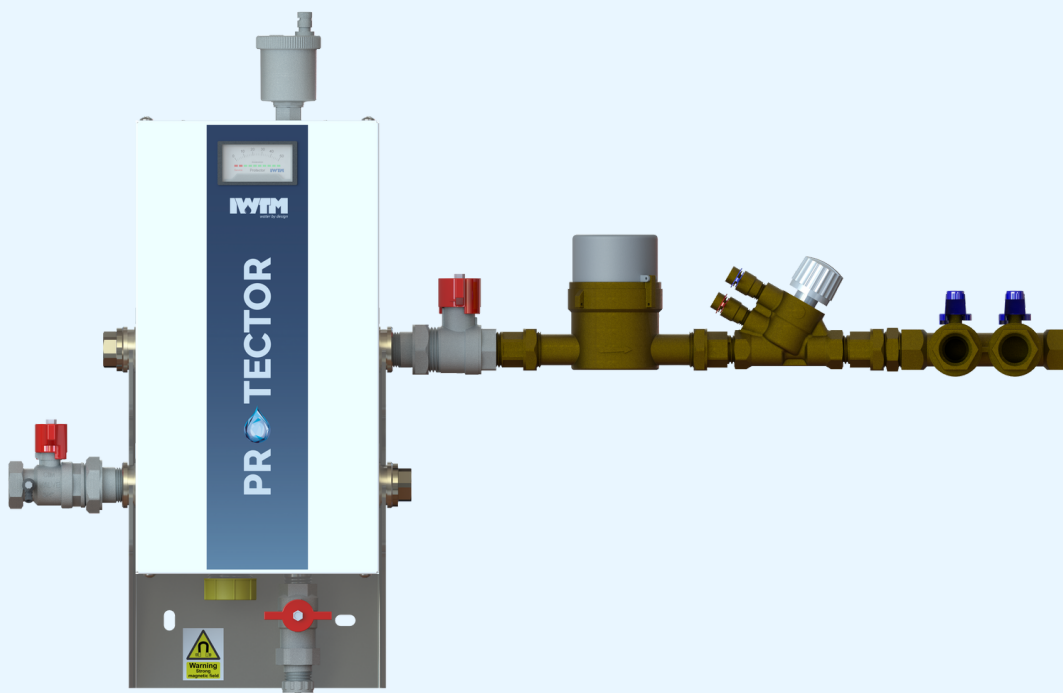

Environmental Culture Change

be a part of it

clean | protect | prevent



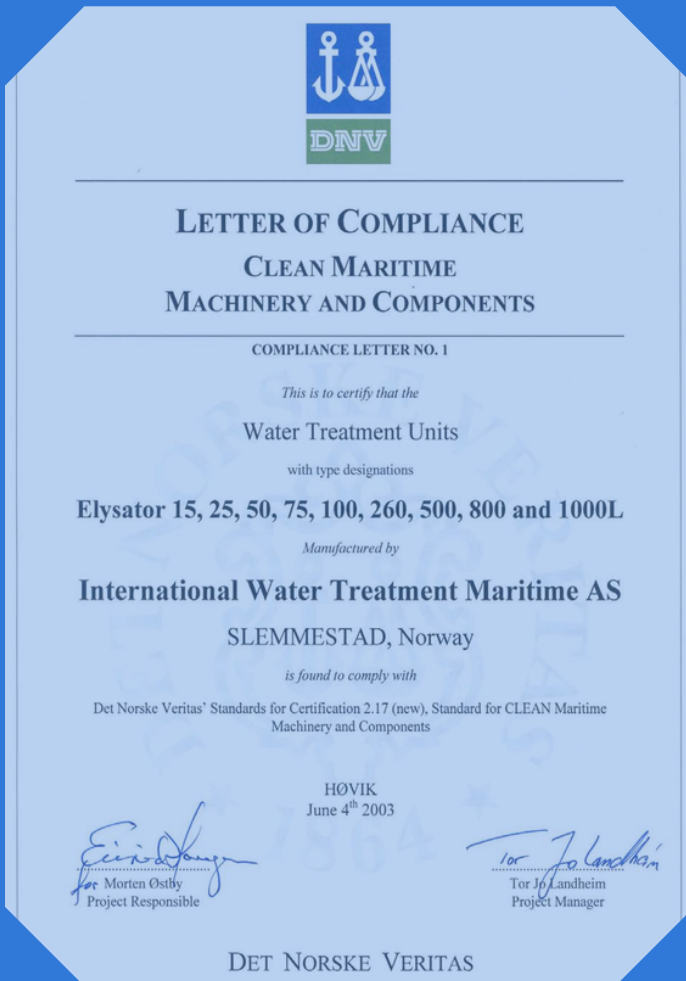

Founded in 1992, IWTM have been working with chemical free water treatment using electrochemistry for over 30 years and have offices in Norway, UK, Finland, Sweden, Canada, USA and a worldwide presence in the Marine sector.

We have developed models specifically suited to the higher demands of the marine industry operating at higher pressures and higher temperatures. The marine products are provided worldwide on the world's largest cruise ships working with the leading operators in this sector.

Having secured DNV approval in 2003, we are still the only chemical free water treatment manufacturer to have this certification and approval. DNV is a globally leading quality assurance and risk management company operating in more than 100 countries.

The IWTM Protector™ is our most recently developed product. The Protector range is now available to our land-based customers.

Version 1: Nov 2023

SUTTON BUSINESS CENTRE
RESTMOR WAY WALLINGTON
SM6 7AH

WWW.IWTM-UK.COM
T: +44 208 255 2903
E: INFO@IWTM-UK.COM